



SAFETY DEVICES

FOR MACHINERY AND RACKING SYSTEMS



The high technological standards reached by industrial manufacturing plants along with the current standards and regulations regarding safety at the workplace call for the selection of appropriate safety components. For this reason **Accessafe** designs and manufactures both standard modular guard systems and full custom solutions which fulfill regulations requirements and the production needs of our customers, combining the highest standard of safety and total efficiency.

PARTNER FOR YOUR SAFETY

Accesssafe team's technical skills in engineering standard products and providing consults for special projects combine with high-tech production methods which allow for in-house manufacturing of guarding systems realized with the most suitable raw materials: electro-welded mesh panels and steel metal sheet, aluminum profiles, polycarbonates, sound-absorbant systems, hardware and fixing components are all made in the same factory in order to guarantee total quality control. At the same manufacturing unit, all products undergo coating process, then they are assembled for functional testing and prepared for easy and quick installation. No matter how big or complex the project, Accesssafe is able to guarantee the same level of expertise to over 3000 orders a year: from revamping of big plants which need upgrading to meet the directive requirements to the tooling machine which needs to be marketed for the first time.

STOCK READY PRODUCTS AND CE CERTIFICATIONS

Accesssafe works on a production surface of over 9000 sq m 20% of which is dedicated to stock ready CE marked products which customers can purchase through the [myAccess](#) portal and receive in a short and guaranteed time. All items will be delivered perfectly packaged and ready to be installed with few simple tools along with the set of certificates (required to complete the plant technical file): welding certification (ISO-3834-3) and product certification with TÜV Nord guarantee (DM 14554-17 -Fixed and Mobile Guard system).

FUNCTIONAL TESTS AND CRASH TEST UNI ISO 14120

Each of Accesssafe's special projects, as for example manual and automatic doors, is pre-assembled, filmed and tested at our test centre in the presence of our customer. No detail is left to chance in order to prevent time wasting during machinery testing in the same area or at certified laboratories. Quadra and Penta Ranges (assembled with META fixing system patent N. 222845), and Modula range (assembled with MODULA fixing system European patent n. 3708742) have brilliantly passed the strict mechanic resistance tests from inside-outside impacts according to the so called "rigid body" procedure contained in the UNI EN ISO 14120 part 4.2.2 with resistance peaks up to 1600J.

CUSTOMER SERVICE DEPARTMENT

Besides designing and manufacturing almost all that is needed to guarantee machinery safety, Accesssafe is committed to supply accessory services which relieve the customer from tasks which are considered inefficient during plant testing and installation. A team of assembly technicians is made available free of charge to those customers who manufacture machines in batches and, when purchasing for the first time, need to learn the tricks which allow for minimal installation time. The same team is made available in Italy and Europe for any other installation requirements. This service can be requested by simply contacting your Accesssafe Sales Agent.

Our service department also caters for the following: setting of cabled sensors, components' marking and labeling as per layout, pre-assembly of special parts and components, removal and disposal of guards that need to be substituted, scheduled maintenance.

EXPERIENCE, TRAINING AND CONSULTING

To guarantee ever growing high-tech solutions, Accesssafe constantly invests in continuous training for employees. The company can boast a technical department with highly qualified specialization and experience in the design of safety solutions for industrial processes. The competence of our CECE and CMSE (TÜV Nord) qualified experts are made available to our customers in order to guarantee a flawless service ranging from risk analysis, to component supply, right up to the drafting of the technical file.

STANDARD E TAILOR MADE

To comply to our customers' needs, Accesssafe designs and manufactures both standard, stock-ready, products which can be delivered in 5 working days such as panels and posts in RAL colours 9005, 7035, 1018 and special tailor made products. Accesssafe technical department can also supply, upon request, its own layout for which an accompanying certification is issued.



01. FIELD OF APPLICATION MACHINERY GUARD SYSTEMS FRAMED RANGE FRAMELESS RANGE	11	02. FIELD OF APPLICATION MACHINERY GUARD SYSTEMS INOX RANGE	81
FRAMED RANGE	12	INOX PANEL RANGE	84
Penta range	13	INOX No Food range	85
Anti-finger TEC range	15	INOX Splash range	87
Anti-phalanx RT range	17	INOX POSTS RANGE	88
Polycarbonate range	19	META INOX No Food	88
Polylam range	21	META INOX Splash	89
Polyplus range	23	ACCESSORIES FOR INOX NO FOOD RANGE	90
Lamiera range	25	HINGED AND SLIDING DOORS INOX RANGE	93
Polylam Plus range	27	Single leaf INOX No Food	94
Oblo range	29	Double leaf INOX No Food	95
M55 Automotive range	31	Single leaf INOX Splash	96
FRAMELESS RANGE	32	Double leaf INOX Splash	97
Modula range	33	Upper binary single opening INOX No Food	98
FRAMED PANEL POSTS	34	Upper binary single opening INOX Splash	99
META	35	INOX locking systems	100
VITERIA	36	03. FIELD OF APPLICATION MATERIAL HANDLING AND LOGISTICS	103
M55 Automotive	37	ANTI COLLAPSE PANELS	104
FRAMELESS PANEL POSTS	38	SI.S.MA range	105
MODULA	39	ACCESSORIES FOR SI.S.MA	106
ACCESSORIES FOR FRAMED PANELS	40	SHELF MESH RACKS	108
ACCESSORIES FOR POSTS	44	PRESSED GRATING RACKS	110
ACCESSORIES FOR FRAMELESS PANELS AND MODULA POSTS	46		
UNIVERSAL ACCESSORIES	48		
HINGED DOORS	50		
Single hinged door	52		
Double hinged door	53		
Hinged doors locking systems	54		
Special locking systems	55		
SLIDING DOORS	56		
Upper binary single opening	58		
Upper binary single and opposing opening	59		
Bottom track single opening	60		
Bottom track single and opposing opening	61		
Roller bearings single opening	62		
Roller bearings single and opposing opening	63		
Sliding doors locking systems	64		
Accessories for doors	65		
Brackets for safety microswitches	66		
AUTOMATED MOVABLE GUARDS	68		
Vertical pneumatic door Alpha	71		
Vertical pneumatic door Alpha 2	73		
Electric vertical door Beta	75		
Electric vertical door Beta 2	77		
Manual vertical door Tau	79		

MACHINERY DIRECTIVE & SAFETY NORMS AND REGULATIONS AT THE WORKPLACE

All EC and international norms and regulations the customer must comply to.

—

Machinery Directive 2006/42/CE

UNI EN ISO 14120

General requirements for the design, construction of fixed and movable guards.

5.3.2: Guards must be designed to prevent crushing or trapping points with parts of the machinery or with other guards.

5.3.9: Fixed guards must be fixed by systems that can be opened or removed only with tools.

5.3.10: Where possible, guards must be incapable of remaining in place without their fixings.

5.9: Where full visibility of the machine through the guard is needed, suitable materials or mesh panels must be selected in order to guarantee an appropriate open area and appropriate colours to allow visibility.

5.19: RETAINED FASTENING – should removal of fixed guards be liable, for example to allow maintenance, Their fixing systems must remain attached to the guards or to the machinery.

—

UNI EN ISO 13857

Safety distances to prevent free access to machinery hazard zones by higher and/or lower limbs.

UNI EN ISO 13854

Minimum gaps to avoid crushing of parts of the human body.

UNI EN ISO 14119

Interlocking devices associated with guards, Principles for design and selection.

UNI EN ISO 14122-3

Permanent means of access to machinery – Stairs, stepladders and guard-rails.



SAFETY DISTANCES

All norms and directives the customer must comply to.

UNI EN ISO 13857 - 4.2.2

Guard height to prevent free access of operator's higher limbs.

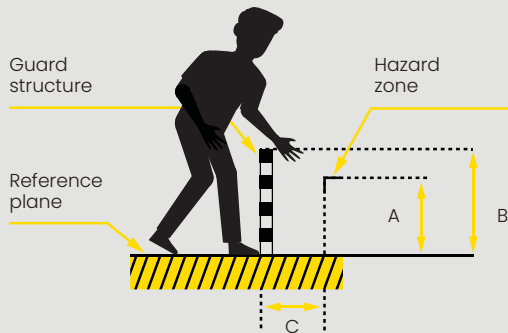

A: height of hazard zone
 B: height of protection guard
 C: horizontal distance from hazard zone

Table 2 - High risk

Dimensions in mm

Height of hazard zone A	Height of protection structure B									
	1000	1200	1400	1600	1800	2000	2200	2400	2500	2700
	Horizontal distance from hazard zone C									
2700	0	0	0	0	0	0	0	0	0	0
2600	900	800	700	600	600	500	400	300	100	0
2400	1100	1000	900	800	700	600	400	300	100	0
2200	1300	1200	1000	900	800	600	400	300	0	0
2000	1400	1300	1100	900	800	600	400	0	0	0
1800	1500	1400	1100	900	800	600	0	0	0	0
1600	1500	1400	1100	900	800	500	0	0	0	0
1400	1500	1400	1100	900	800	0	0	0	0	0
1200	1500	1400	1100	900	700	0	0	0	0	0
1000	1500	1400	1000	800	0	0	0	0	0	0
800	1500	1300	900	600	0	0	0	0	0	0
600	1400	1300	800	0	0	0	0	0	0	0
400	1400	1200	400	0	0	0	0	0	0	0
200	1200	900	0	0	0	0	0	0	0	0
0	1100	500	0	0	0	0	0	0	0	0

UNI EN ISO 13857 - 4.2.4.1

Safety distance to prevent access with higher limbs.



Table S_r reports regular opening types.

Dimension of opening "e" corresponds to the side of a squared opening, the diameter of a rounded opening and the smaller side of a loopholed opening.

For openings wider than 120mm, safety distances should conform with requirements stated in UNI EN ISO 13857 4.2.2.

Table 2 - People 14 yrs of age or older

Dimensions in mm

Part of the body	Illustration	Opening	Safety distance S_r		
			Loopholed	Squared	Rounded
Finger tip		$e \leq 4$	≥ 2	≥ 2	≥ 2
		$4 < e \leq 6$	≥ 10	≥ 5	≥ 5
Finger to knuckle		$6 < e \leq 8$	≥ 20	≥ 15	≥ 5
		$8 < e \leq 10$	≥ 80	≥ 25	≥ 20
Hand		$10 < e \leq 12$	≥ 100	≥ 80	≥ 80
		$12 < e \leq 20$	≥ 120	≥ 120	≥ 120
		$20 < e \leq 30$	$\geq 850^a$	≥ 120	≥ 120
Arm to shoulder articulation		$30 < e \leq 40$	≥ 850	≥ 200	≥ 120
		$40 < e \leq 120$	≥ 850	≥ 850	≥ 850

The lines highlighted in the table show the part of the body involved according to opening dimension.

a) If the length of the loophole opening is lower or equal to 65mm, thumb acts as a block and safety distance can be reduced to 200mm.

SAFETY DISTANCES

All standards and directives a customer must comply with.

UNI EN ISO 13857 - 4.3

Reaching hazard zone with lower limbs through regular shaped openings .

Generally speaking, safety distances should be calculated using tables 1 to 6 for the higher limbs.

When free access with higher limbs is not possible, values reported in table 7 can be used in order to establish safety distances for lower limbs.

The dimension of opening "e" corresponds to the side of a squared opening, the diameter of a round opening and the smaller side of a loophole opening.

Values reported in table 7 are valid independently from clothing and footwear and are applied to people from the age of 14.

Table 7 - people of 14 yrs of age or older

Dimensions in mm

Lower limb part	Illustration	Opening	Safety distance S_r	
			Loophole	Squared or Rounded
Toe-tip		$e \leq 5$	0	0
		$5 < e \leq 15$	≥ 10	0
Toe		$15 < e \leq 35$	$\geq 80^a$	≥ 25
Foot		$35 < e \leq 60$	≥ 180	≥ 80
		$60 < e \leq 80$	$\geq 650^b$	≥ 180
Leg (from toe tip to knee)		$80 < e \leq 95$	$\geq 1100^c$	$\geq 650^b$
Leg (from toe-tip to groin)		$95 < e \leq 180$	$\geq 1100^c$	$\geq 1100^c$
		$180 < e \leq 240$	not admissible	$\geq 1100^c$

a) If loophole opening length is lower or equal to 65mm, big-toe acts a stop and safety distance can be reduced to 200mm.

b) Values corresponds to leg (from toe-tip to knee).

c) Values corresponds to leg (from toe-tip to groin) .

NOTE: loophole opening with $e > 180$ mm and square or round opening with

$e > 240$ mm allow free access to the whole body.



CRASH TEST UNI EN ISO 14120

Quadra and Penta Ranges are assembled with META fixing system patent N. 222845, and Modula range is assembled with MODULA fixing system European patent n. 3708742. These systems have undergone strict dynamic resistance tests from inside to outside impacts according to the so called "rigid body" procedure contained in the UNI EN ISO 14120 passing the test with flying colours for impacts above 115J. Safety distances conforming with point 4.2.2 have been applied.



DESIGN IN SAFETY





FIELD OF APPLICATION

MACHINERY GUARDS

FRAME RANGE | FRAMELESS RANGE



Access guard ranges with frame and frameless have been developed according to three essential criteria: flexibility, quick assembly and compliance with safety requirements as per Machinery Directive 2006/42/CE. These guard systems have been designed to meet the demand for machinery safety and the segregation of work areas. Access frame and frameless systems present several ranges tested to resist to impacts above 115J, as required by the UNI EN ISO 14120 standard.

SAFETY DISTANCE

200mm | 120mm | 100mm | 20mm | 0mm

PANEL FRAME

20x20mm | 30x30mm

POST BASE

WELDED | ADJUSTABLE

TUBULAR POST

40x40mm | 60x60mm | 80x80mm

COLOURS (RAL)

Panels undergo epoxy coating.



9005



1018

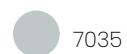

7035

Other colours available upon request

120 mm

UNI EN ISO 13857

Distance from hazard zone



UNI EN ISO 14120

Statement of conformity TÜV Nord : DM - 124554-17
in combination with META posts

Self-certification
in combination with VITERIA posts

For all types of machinery



FIELD OF APPLICATION



PENTA RANGE

PENTA electro-welded mesh machinery protection guard have 20x100mm mesh and 3mm thread. Frames come in two sizes:



Penta protection guards are employed to safeguard plants and machinery whose distance from danger area must be equal or above 120mm.

The panel provides a standard fixing hole for retained fastening and other accessories.

MESH: 20x100mm thread 3mm

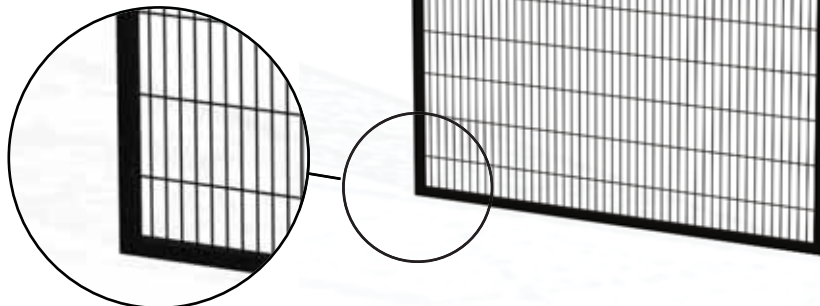

250 400 700 800 1000 1200 1500 2000 (mm)

2400
2100
1900
1300
960 *

COMPATIBILITY

Panel fixing system - META posts and VITERIA posts

COLOURS (RAL)

Panels undergo epoxy coating.



9005



1018

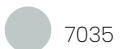

7035

Other colours available upon request

* For guards at a height lower than 1400mm, extra safety measures apply as required by UNI EN ISO 13857 standard.

• For guards with height of 2400mm a width 2000mm is not available.

100 mm

UNI EN ISO 13857

Distance from hazard zone



UNI EN ISO 14120

Statement of conformity TÜV Nord : DM - 124554-17
in combination with META posts

Self-certification
in combination with VITERIA posts

Assembly stations

Reduced space stations

Industrial robots



FIELD OF APPLICATION

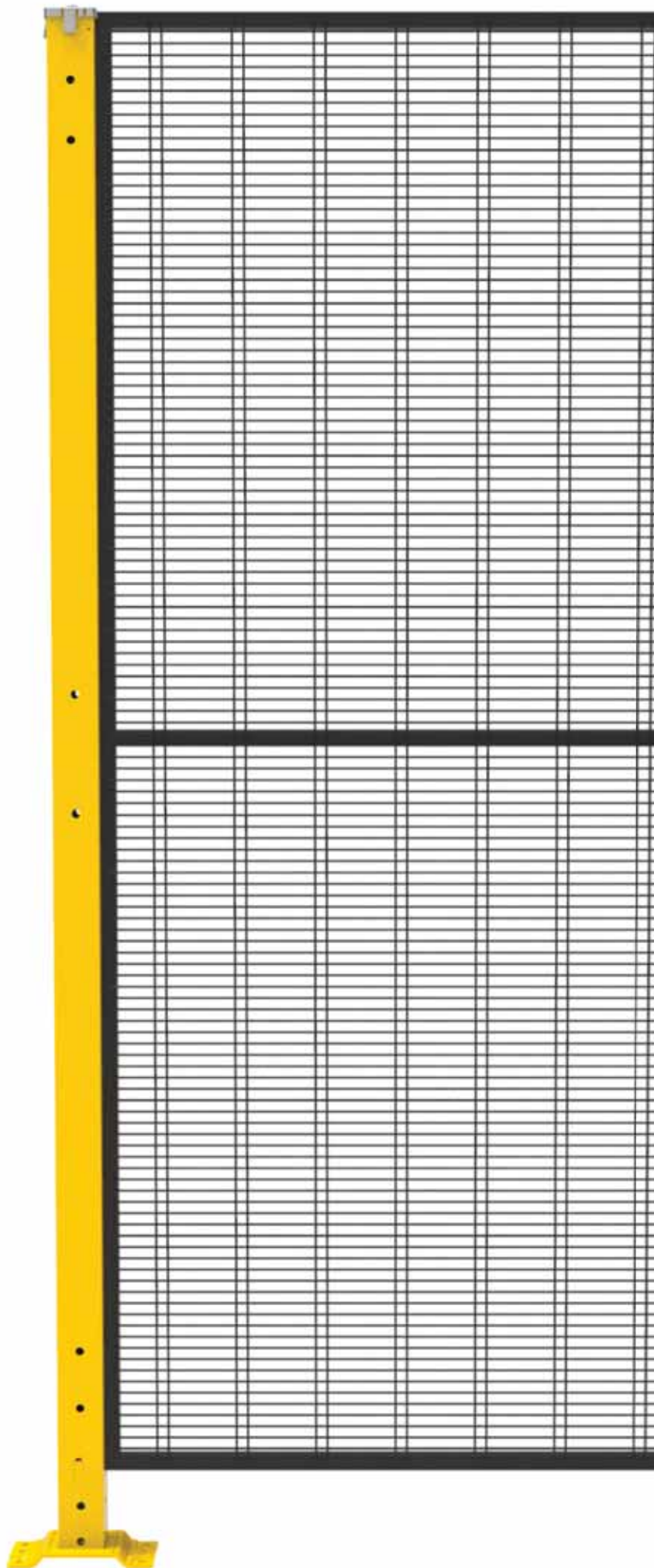

TEC FINGER-PROOF RANGE

TEC electro-welded mesh machinery protection guard have 15x15x105mm mesh and 3mm thread.
Frames come in two sizes:



TEC protection guards are employed to safeguard plants and machinery whose distance from danger area must be equal or above 100mm.

The panel provides a standard fixing hole for retained fastenings and other accessories.

250 400 700 800 1000 1200 (mm)

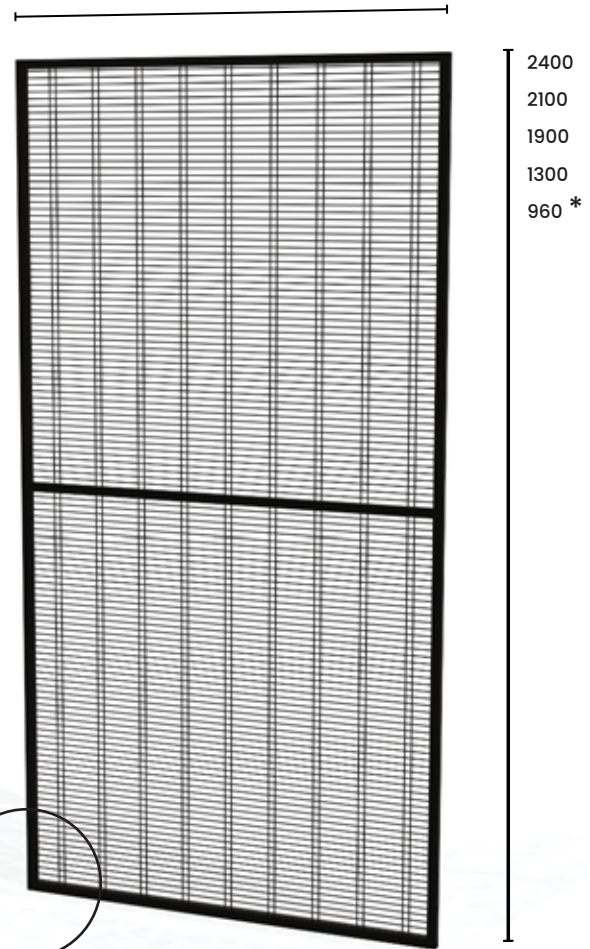

MESH: 15x15x105mm thread 3mm



COMPATIBILITY

Panel fixing system - META posts and VITERIA posts

COLOURS (RAL)

Panels undergo epoxy coating.

● 9005

● 1018

● 7035

Other colours available upon request

* For guards at a height lower than 1400mm, extra safety measures apply as required by UNI EN ISO 13857 standard.

20 mm

UNI EN ISO 13857

Distance from hazard zone



UNI EN ISO 14120

Statement of conformity TÜV Nord : DM - 124554-17
in combination with META posts

Self-certification
in combination with VITERIA posts

For all types of machinery



FIELD OF APPLICATION

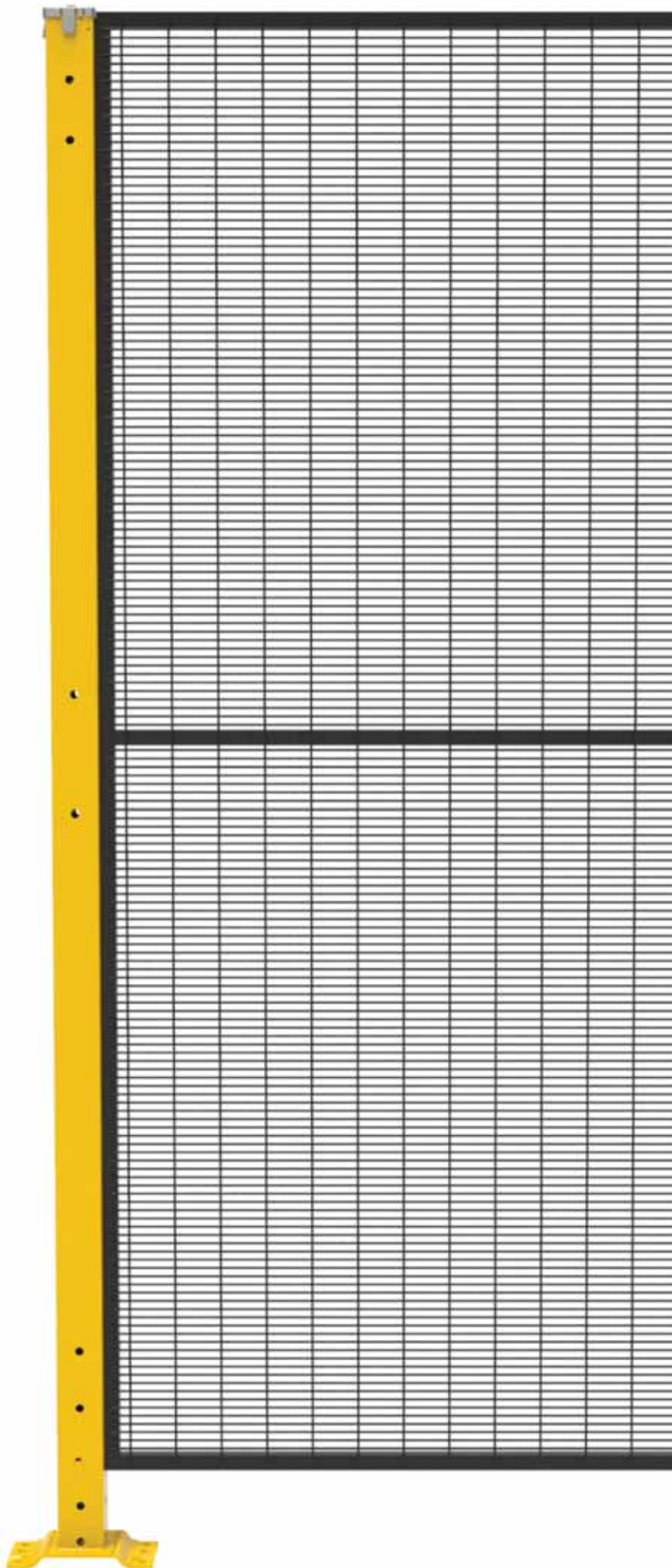

RT PHALANX-PROOF RANGE

RT electro-welded mesh machinery protection guard have 60x11mm mesh and 3mm thread.
Frames come in two sizes:



RT protection guards are employed to safeguard plants and machinery whose distance from danger area must be equal or above 20mm.

The panel provides a standard hole for retained fastenings and other accessories

250 400 700 800 1000 1200 (mm)

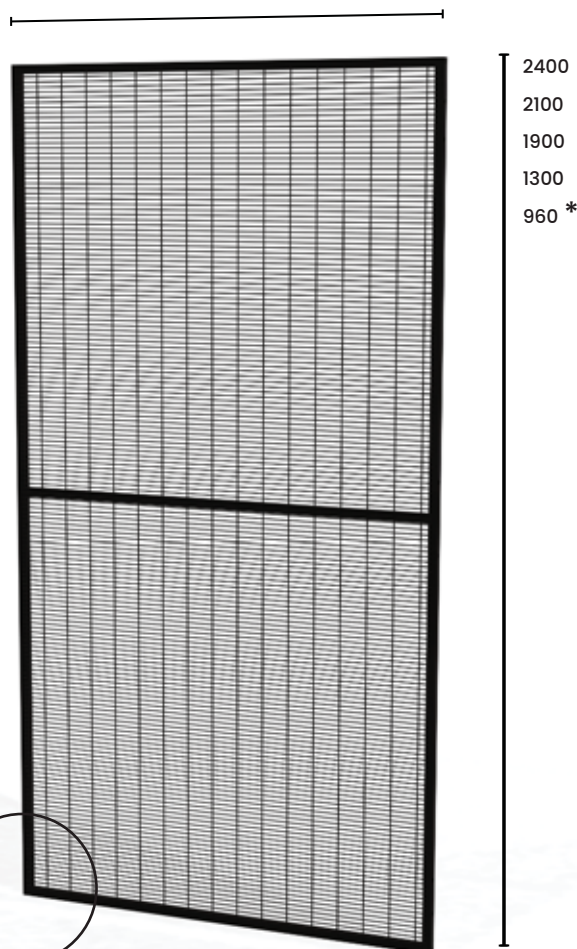

MESH: 60x11mm thread 3mm

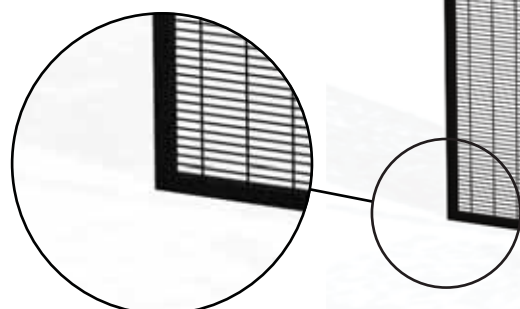

COMPATIBILITY

Panel fixing system - META posts and VITERIA posts

COLOURS (RAL)

Panels undergo epoxy coating.

● 9005

● 1018

● 7035

Other colours available upon request

* For guards at a height lower than 1400mm, extra safety measures apply as required by UNI EN ISO 13857 standard.

20 mm

UNI EN ISO 13857

Distance from hazard zone



UNI EN ISO 14120

Statement of conformity TÜV Nord : DM - 124554-17
in combination with META posts

Self-certification
in combination with VITERIA posts

**For machinery which requires
material containment**



FIELD OF APPLICATION

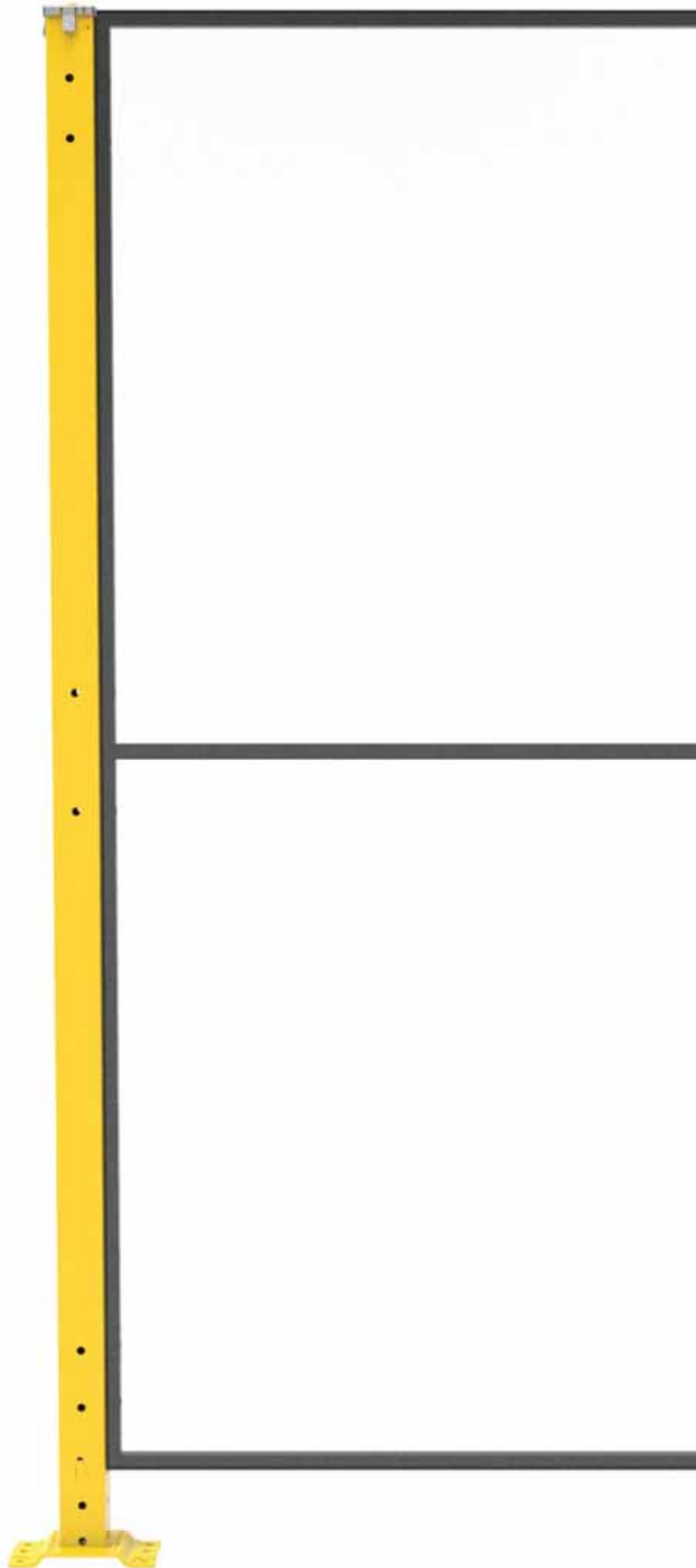

POLICARBONATE RANGE

Polycarbonate machinery safety guards are 4mm thick and have a riveted sheet fixed to frame. Frames come in two sizes:



These guards are employed when the danger area is close and prevention from dust, sparks or liquid leaks is needed yet visibility within danger area is guaranteed. Distance from danger area can be as little as 0mm.

The panel is provided with a standard hole to house toughening retained fastenings and other accessories.

250 400 700 800 1000 1200 1500 (mm)

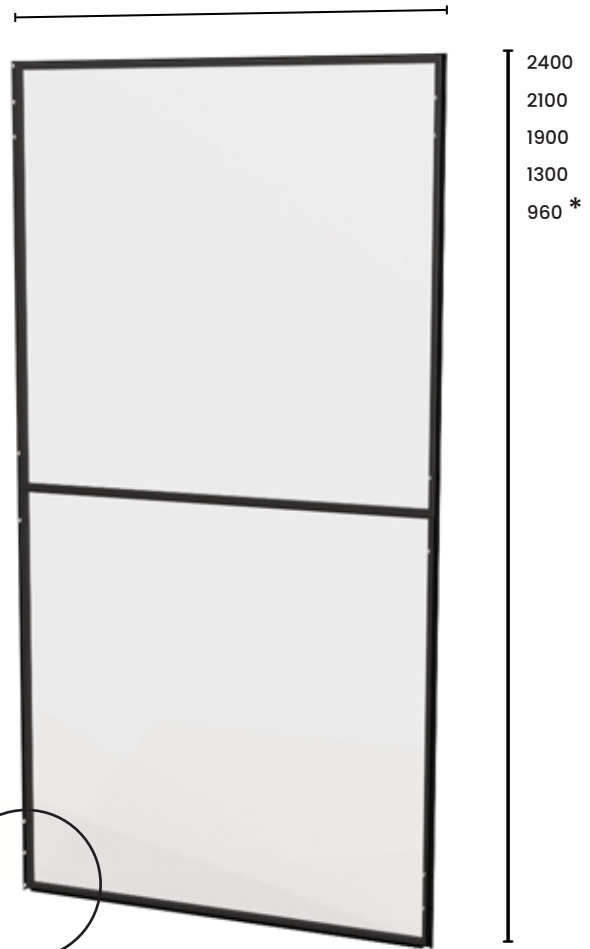

POLYCARBONATE THICKNESS: 4mm

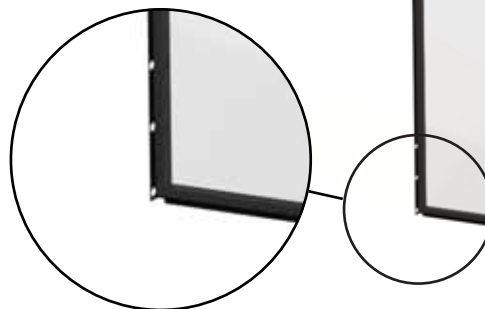

COMPATIBILITY

Panel fixing system - META posts and VITERIA posts

COLOURS (RAL)

Panels undergo epoxy coating.

● 9005

● 1018

● 7035

Other colours available upon request

* For guards at a height lower than 1400mm, extra safety measures apply as required by UNI EN ISO 13857 standard.

0 mm

UNI EN ISO 13857

Distance from hazard zone



UNI EN ISO 14120

Statement of conformity TÜV Nord : DM - 124554-17
in combination with META posts

Self-certification
in combination with VITERIA posts

**For machinery which requires
material containment**



FIELD OF APPLICATION



POLYLAM RANGE

PolyLam machinery safety guards are composed by 1mm metal sheet for the lower part and 4mm polycarbonate riveted to the frame for the upper part. Frames come in two sizes:



These guards are employed when the danger area is close and prevention from dust, sparks or liquid leaks is needed yet visibility within danger area is guaranteed. Distance from danger area can be as little as 0mm.

The panel is provided with a standard hole to house toughening retained fastenings other accessories.

METALSHEET THICKNESS: 1mm
POLYCARBONATE THICKNESS: 4mm

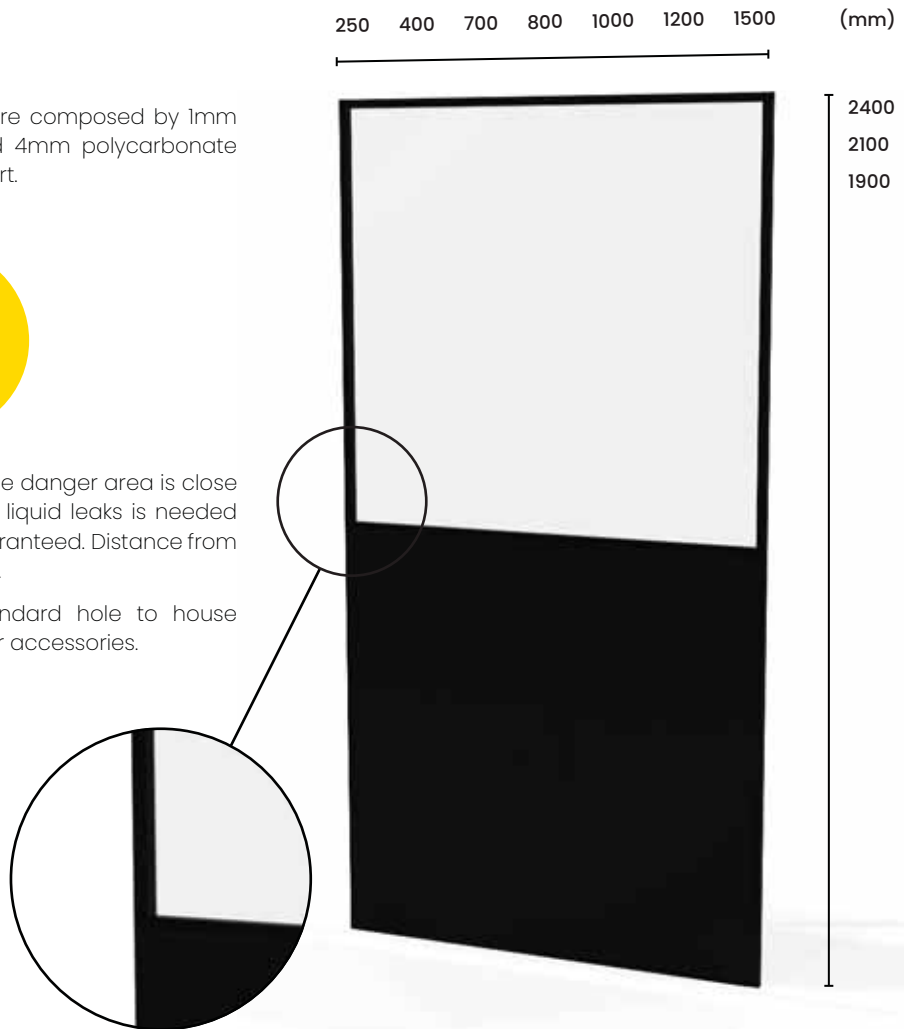

COMPATIBILITY

Panel fixing system - META posts and VITERIA posts

COLOURS (RAL)

Panels undergo epoxy coating.

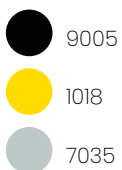

Other colours available upon request

0 mm

UNI EN ISO 13857

Distance from hazard zone



UNI EN ISO 14120

Statement of conformity TÜV Nord : DM - 124554-17
in combination with META posts

Self-certification
in combination with VITERIA posts

**For machinery which requires
material containment with high
impact energy**



FIELD OF APPLICATION



SERIE POLY PLUS

PolyPlus machinery safety guards are composed by 1,5mm laser-worked metal sheet for the lower part and 4mm polycarbonate for the upper part. Frames come in two sizes:

FRAME
mm

20

FRAME
mm

30

These guards are employed when the danger area is close and prevention from dust, sparks or liquid leaks is needed yet visibility within danger area is guaranteed. Distance from danger area can be as little as 0mm.

The panel is provided with a standard hole to house toughening retained fastenings and other accessories.

METALSHEET THICKNESS: 1,5mm
POLYCARBONATE THICKNESS: 4mm

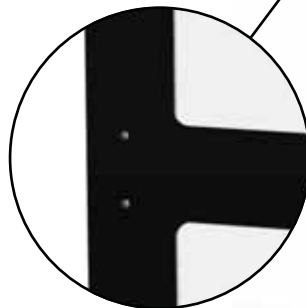

400 700 800 1000 1200 1500 (mm)



COMPATIBILITY

Panel fixing system - META posts and VITERIA posts

COLOURS (RAL)

Panels undergo epoxy coating.

● 9005

● 1018

● 7035

Other colours available upon request

0 mm

UNI EN ISO 13857

Distance from hazard zone



UNI EN ISO 14120

Statement of conformity TÜV Nord : DM - 124554-17
in combination with META posts

Self-certification
in combination with VITERIA posts

**For machinery which requires
containment from rays
presenting a hazard
for humans**



FIELD OF APPLICATION



LAMIERA (METALSHEET) RANGE

LAMIERA (METAL SHEET) machinery safety guards, 1mm thickness, are point-welded on the frame which comes in two sizes:



These guards are employed when the danger area is close and prevention from dust, sparks or liquid leaks is needed or when operators need guarding in welding areas. Distance from danger area can be as little as 0mm.

The panel is provided with a standard hole to house toughening retained fastenings and other accessories.

250 400 700 800 1000 1200 1500 (mm)

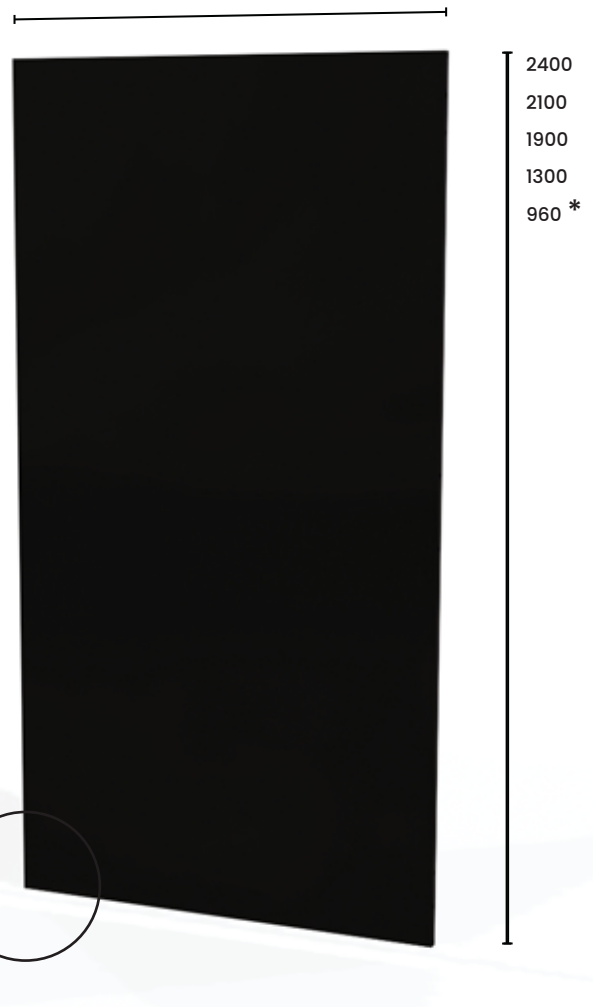

METALSHEET THICKNESS: 1mm

COMPATIBILITY

Panel fixing system - META posts and VITERIA posts

COLOURS (RAL)

Panels undergo epoxy coating.

- 9005
- 1018
- 7035

Other colours available upon request

* For guards at a height lower than 1400mm, extra safety measures apply as required by UNI EN ISO 13857 standard.

0 mm

UNI EN ISO 13857

Distance from hazard zone



UNI EN ISO 14120

Statement of conformity TÜV Nord : DM - 124554-17
in combination with META posts

Self-certification
in combination with VITERIA posts

**For machinery which requires
material containment with high
impact energy**



FIELD OF APPLICATION



POLYLAM PLUS RANGE

PolyLam Plus machinery safety guards are composed by 1mm laser-worked metal sheet for the lower part and 4mm polycarbonate for the upper part. Frames come in two sizes:



These guards are employed when the danger area is close and prevention from dust, sparks or liquid leaks is needed yet visibility within danger area is guaranteed. Distance from danger area can be as little as 0mm.

The panel is provided with a standard hole to house toughening retained fastenings and other accessories.

METALSHEET THICKNESS: 1mm
POLYCARBONATE THICKNESS: 4mm

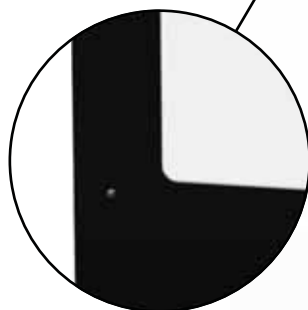

400 700 800 1000 1200 1500 (mm)

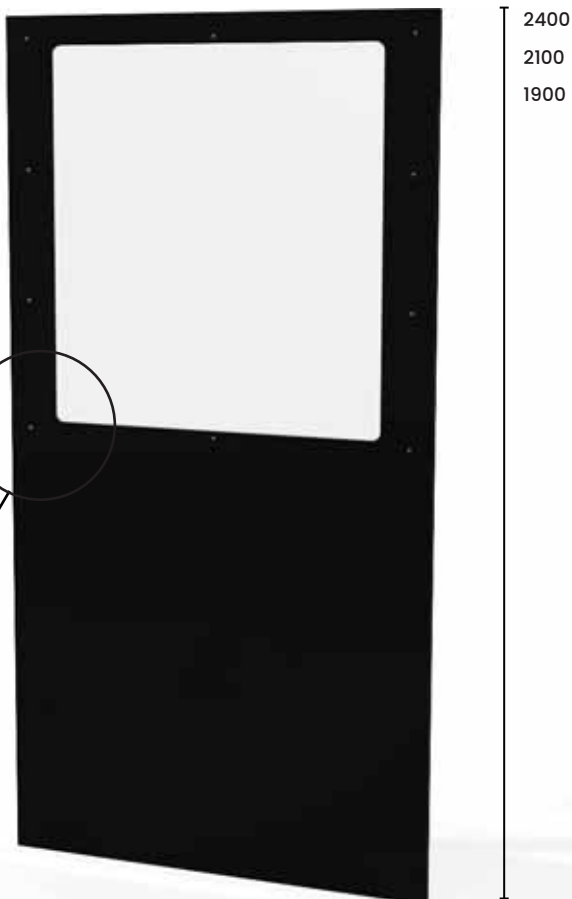

COMPATIBILITY

Panel fixing system - META posts and VITERIA posts

COLOURS (RAL)

Panels undergo epoxy coating.

- 9005
- 1018
- 7035

Other colours available upon request

0 mm

UNI EN ISO 13857

Distance from hazard zone



UNI EN ISO 14120

Statement of conformity TÜV Nord : DM - 124554-17
in combination with META posts

Self-certification
in combination with VITERIA posts

**For machinery which
requires containment from
rays presenting a hazard
for humans and full view of
welding area**



FIELD OF APPLICATION

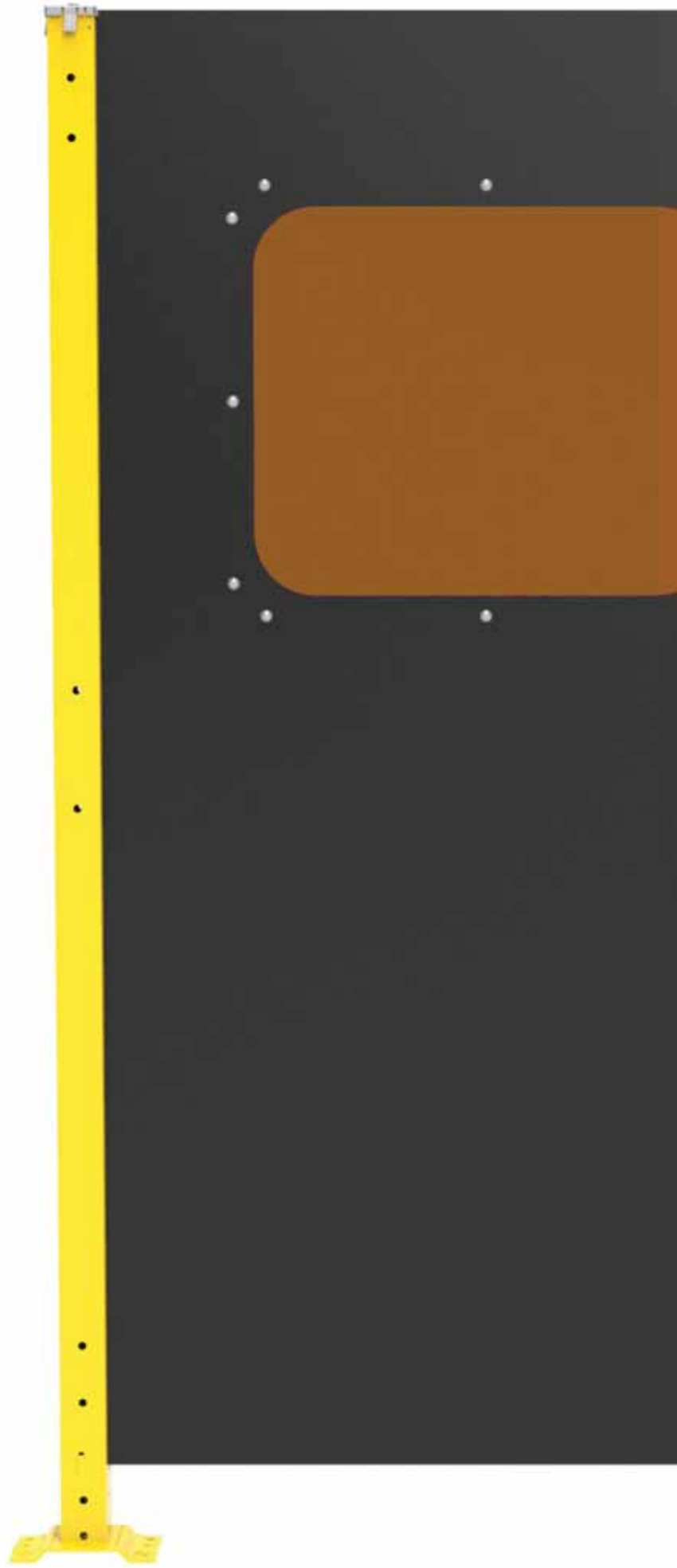

OBLO (PORTHOLE) RANGE

Oblo (Porthole) machinery safety guards are composed by 1mm laser-worked metal sheet and anti-UV porthole in acrylic material.

Frames come in two sizes:



These guards are employed when the danger area is close and welding operations take place allowing visibility within danger area. Distance from danger area can be as little as 0mm.

The panel is provided with a standard hole to house toughening retained fastenings and other accessories.

METALSHEET THICKNESS: 1mm

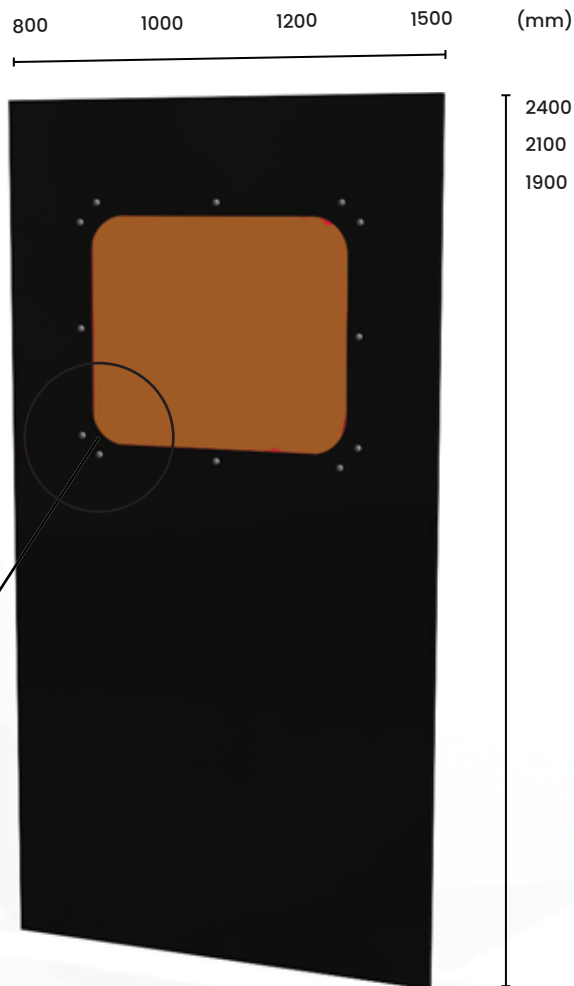
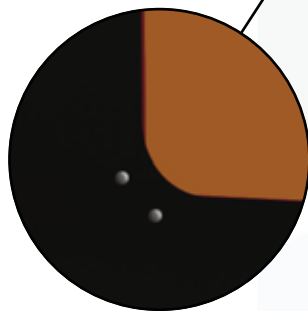

COMPATIBILITY

Panel fixing system - META posts and VITERIA posts

COLOURS (RAL)

Panels undergo epoxy coating.

● 9005

● 1018

● 7035

Other colours available upon request

200 mm

UNI EN ISO 13857

Distance from hazard zone



UNI EN ISO 14120

Self-certification
in combination with M55 posts

**For machinery in the
automotive sector**



FIELD OF APPLICATION

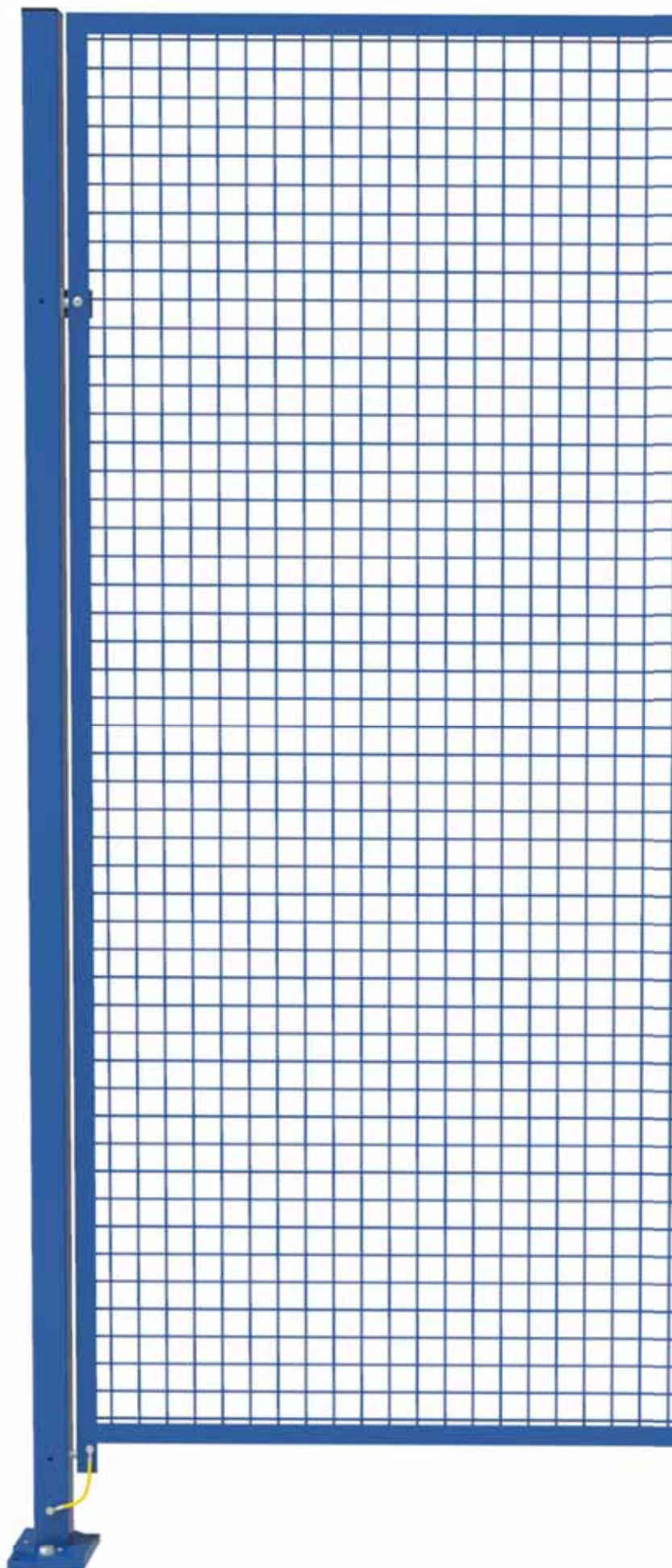

SERIE M55 AUTOMOTIVE

M55 electro welded mesh guards for machinery safety have a 40x40mm mesh and a 4mm thread. The frame, the distinctive element of this range, has an angular shape 30x30x3mm.

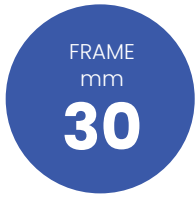

These guards are employed for the safety of plants and machinery for which distance from the hazard zone must be equal or above 200mm.

MESH: 40x40mm thread 4mm

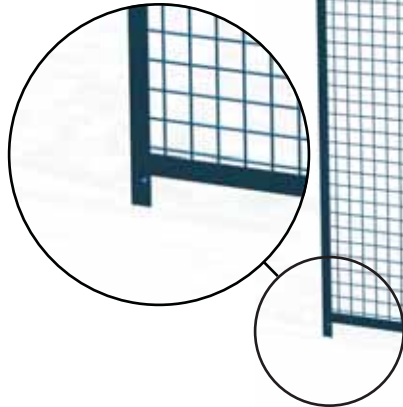

250 400 700 800 1000 1200 1500 (mm)

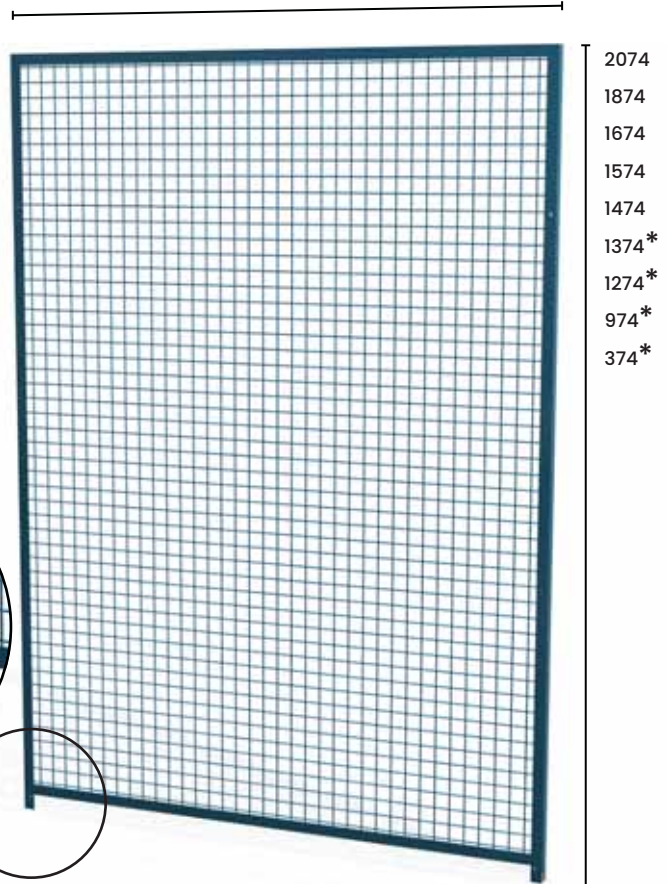

COMPATIBILITY

Panel fixing system - M55 posts

COLOURS(RAL)

Panels undergo epoxy coating



5007

Other colours available upon request

* For guards at a height lower than 1400mm, extra safety measures apply as required by UNI EN ISO 13857 standard.

200 mm

UNI EN ISO 13857

Distance from hazard zone



UNI EN ISO 14120

Self-certification in combination
with MODULA posts

Modula system is composed by panels, posts and
pertinent fixing systems conformant with UNI EN ISO
14120 regulations **except for point 5.18 regarding
anti-climbing**, EN 12100, Machinery Directive
42/2006/CE.

For all types of machinery



FIELD OF APPLICATION

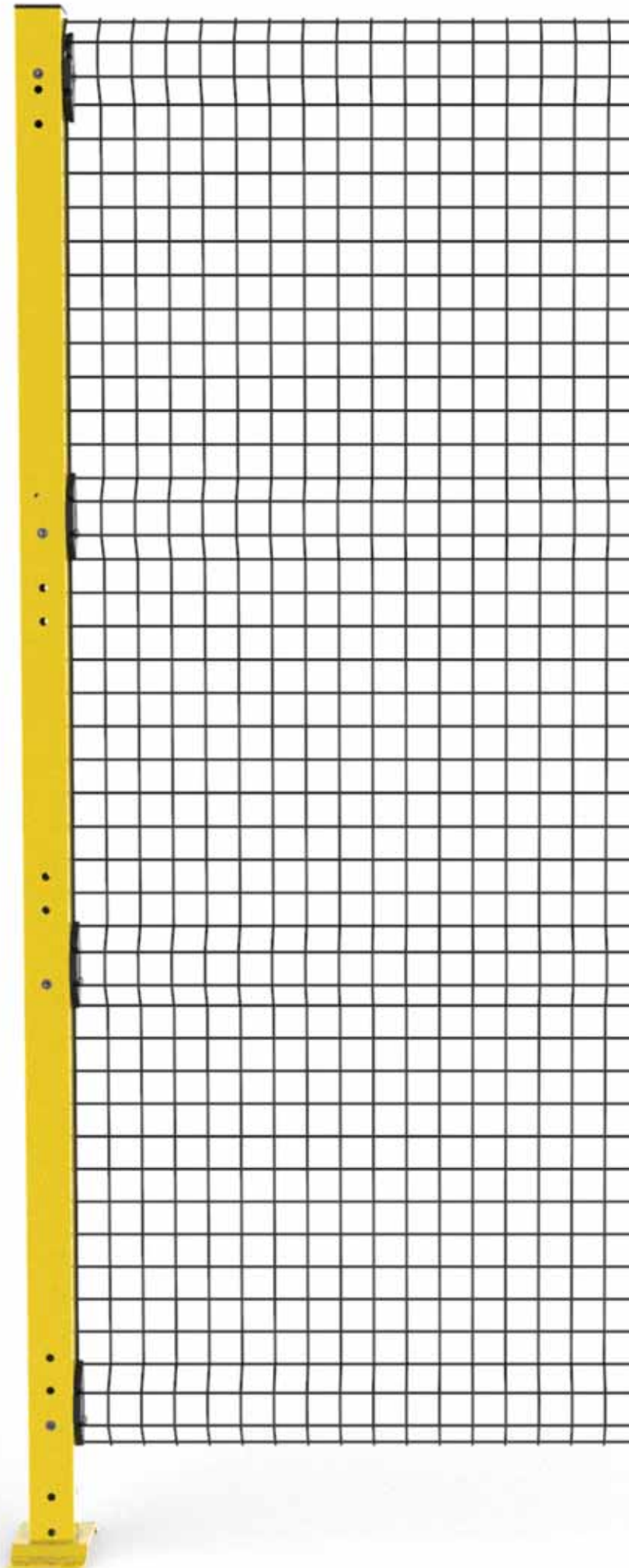

MODULA RANGE

Accesssafe electro-welded mesh safety guard systems in the Modula Range have a 44x44mm mesh, 4 mm thread and present a horizontal bending to guarantee greater stability and stiffness of frameless panels.

These low cost safety guards, are employed to fence guard plants and machinery which require a distance from the the danger area of 200mm or more.

MODULA FIXING SYSTEM EUROPEAN PATENT N° 3708742



The plastic plates with retained fastenings for specific post fixing are provided with the panel and allow 23 mm height regulation.

COMPATIBILITY

Panel fixing system - MODULA posts

COLOURS (RAL)

Panels undergo epoxy coating.

- 9005
- 1018
- 7035

Other colours available upon request

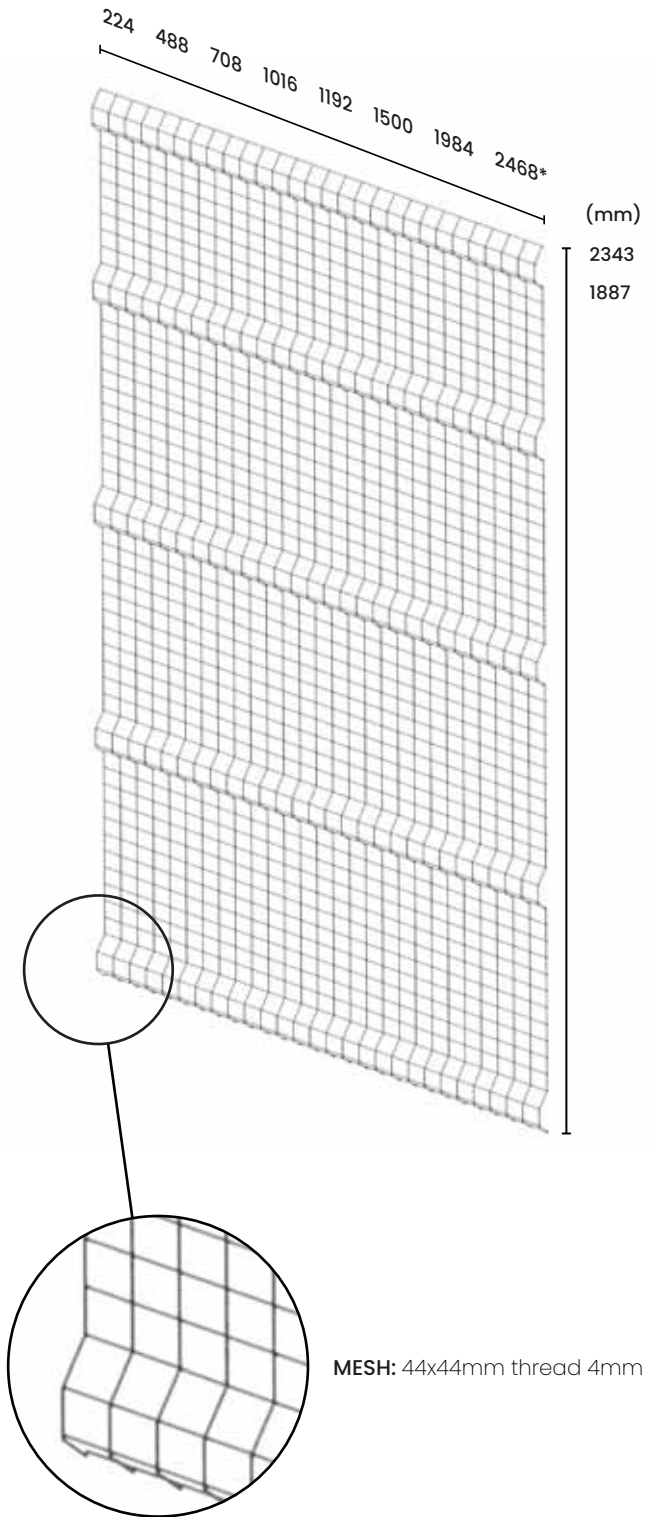

* available only for height 1887

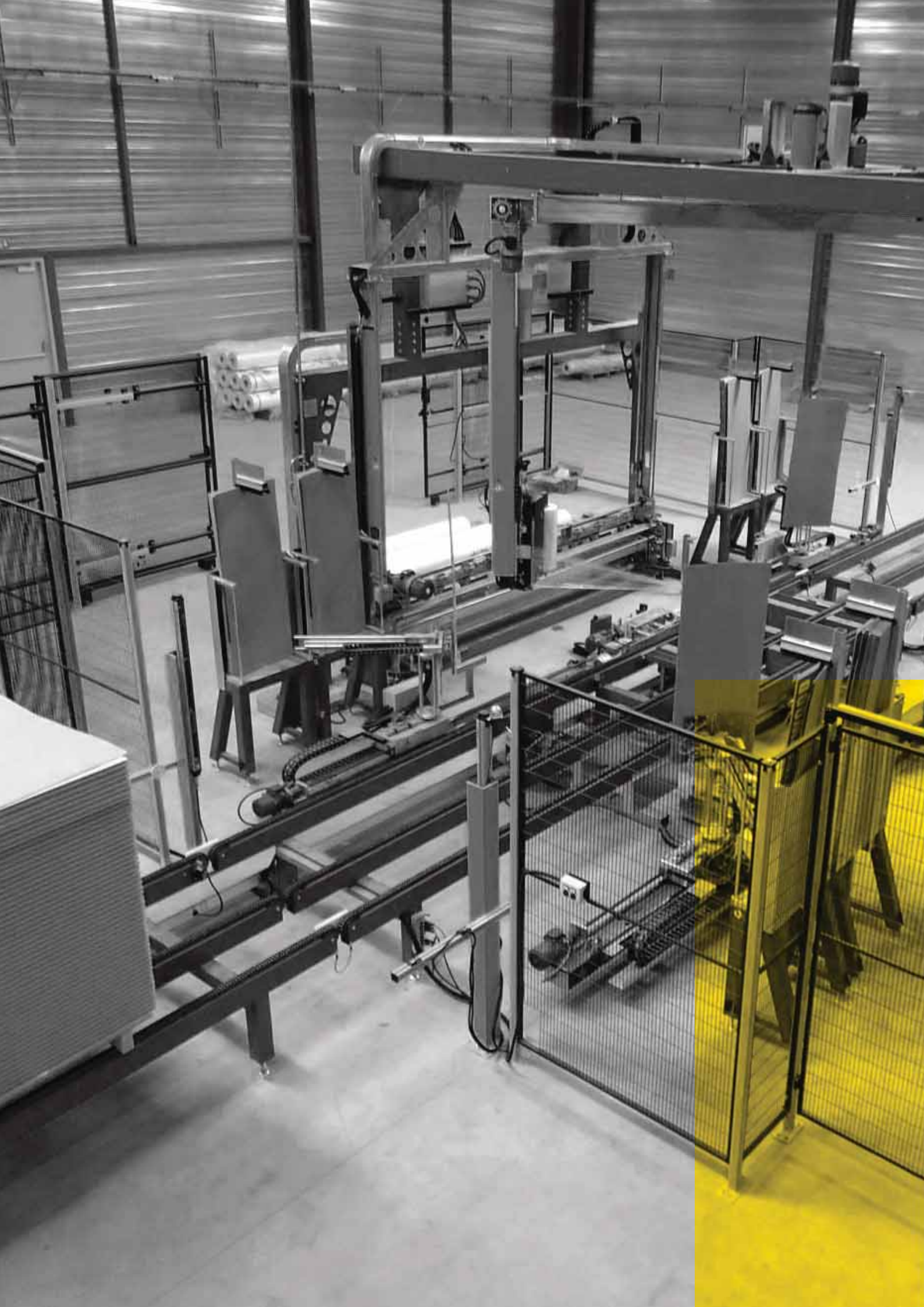

META

Meta posts provide a fast panel-to-post fixing system by means of a retained fastening. This system has been developed in conformity with UNI EN ISO 14120, EN 12100 and Machinery Directive 2006/42/CE. The post has a zinc cap in the upper part and a lower wing laser-fixed to the tubular. The post has a standard hole for retained fastenings and other accessories.

META FIXING SYSTEM EUROPEAN PATENT N° 2226451



BASE, TUBULAR AND FLOOR FITTING

WELDED BASE



☑ **40x40** 2 M8 galvanized steel mechanic plugs

☑ **60x60** 4 M8 galvanized steel mechanic plugs

PLATE SIZE: 192x100mm

Shock absorber function resistance up to 2000N, high resistance central ribbed profile

ADJUSTABLE BASE

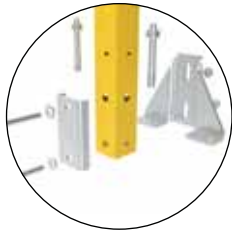

☑ **40x40** 2 M8 galvanized steel mechanic plugs

Height adjusting: 18mm

PLATE SIZE: 35x155mm



☑ **60x60** 4 M8 galvanized steel mechanic plugs

Height adjusting: 25mm

PLATE SIZE: 192x100 mm

Shock absorber function resistance up to 2000N, high resistance central ribbed profile.

(mm)

2520

(section 60x60mm only)

2220

2020

1420

1080 *



COMPATIBILITY

All framed panels

COLOURS (RAL)

Panels undergo epoxy coating.



9005



1018



7035

Other colours available upon request

* For guards at a height lower than 1400mm, extra safety measures apply as required by UNI EN ISO 13857 standard.

VITERIA

VITERIA posts provide a fast panel-to-post fixing system by means of a retained fastening. This system has been developed in conformity with UNI EN ISO 14120, EN 12100 and Machinery Directive 2006/42/CE.

BASE, TUBULAR AND FLOOR FITTING

WELDED BASE



- ☑ **40x40** 2 M8 galvanized steel mechanic plugs
- ☑ **60x60** 4 M8 galvanized steel mechanic plugs

PLATE SIZE: 192x100mm

Shock absorber function resistance up to 2000N, high resistance central ribbed profile

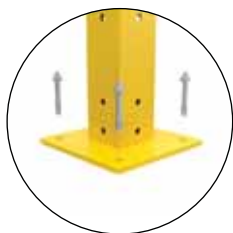

- ☑ **80x80** 4 M8 galvanized steel mechanic plugs

PLATE SIZE: 200x200mm

ADJUSTABLE BASE



- ☑ **40x40** 2 M8 galvanized steel mechanic plugs
- Height adjusting: 18mm

PLATE SIZE: 35x155mm



- ☑ **80x80** 4 M8 galvanized steel mechanic plugs
- Height adjusting: 25mm

PLATE SIZE: 200x200mm

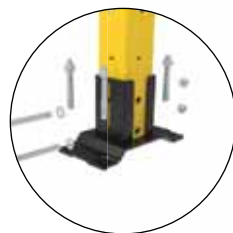

- ☑ **60x60** 4 M8 galvanized steel mechanic plugs
- Height adjusting: 25mm

PLATE SIZE: 192x100 mm

Shock absorber function resistance up to 2000N, high resistance central ribbed profile.

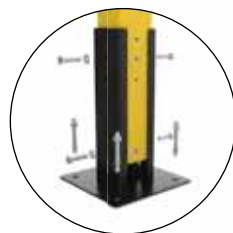

- ☑ **80x80** 4 M8 galvanized steel mechanic plugs
- Height adjusting: 40mm

PLATE SIZE: 200x200mm

(mm)

2520
(section 60x60mm or 80x80mm only)

2220

2020

1420

1080 *

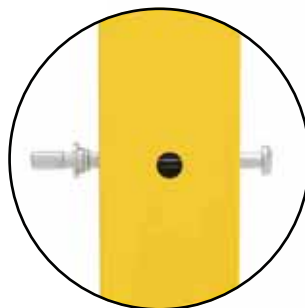

COMPATIBILITY

All framed panels

COLOURS (RAL)

Panels undergo epoxy coating.

● 9005

● 1018

● 7035

Other colours available upon request

* For guards at a height lower than 1400mm, extra safety measures apply as required by UNI EN ISO 13857 standard.

M55 AUTOMOTIVE

M55 posts provides a retained fastening post-to-panel fixing system by means of a tapered screw and a threaded bolt housed in the upper part and a pivot screw in the lower part.

Standard supply includes a grounding cord which is manufactured in conformity with UNI EN ISO 14120, UNI EN ISO 12100, Machinery Directive 2006/42/CE.

BASE, TUBULAR AND FLOOR FITTING

WELDED BASE _____

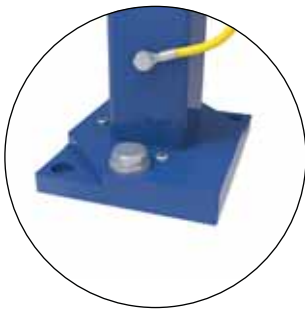

☑ **50X50** ² mechanic M2 zinc coated steel plugs

TRAPEZOID PLATE SIZE: 110x140x8mm

COUNTERPLATE PUSH AND PULL SIZE: 110x140x12mm

COMPATIBILITY

M55 Panels

COLOURS (RAL)

Panels undergo epoxy coating



5007

Other colours available upon request

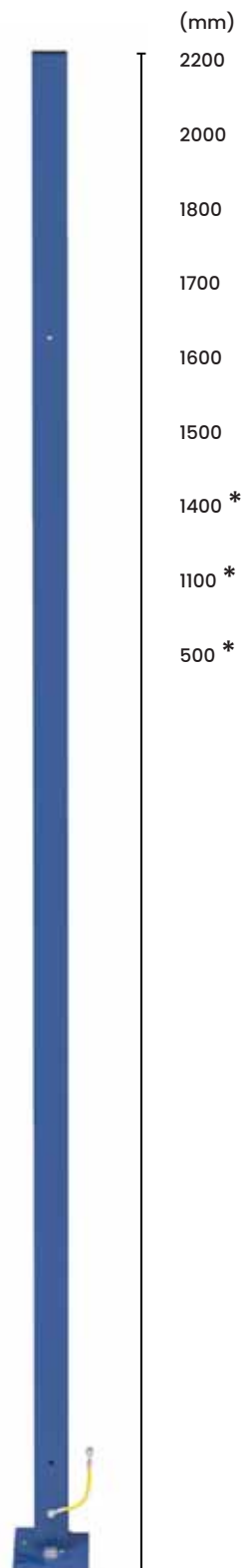

* For guards at a height lower than 1400mm, extra safety measures apply as required by UNI EN ISO 13857 standard.

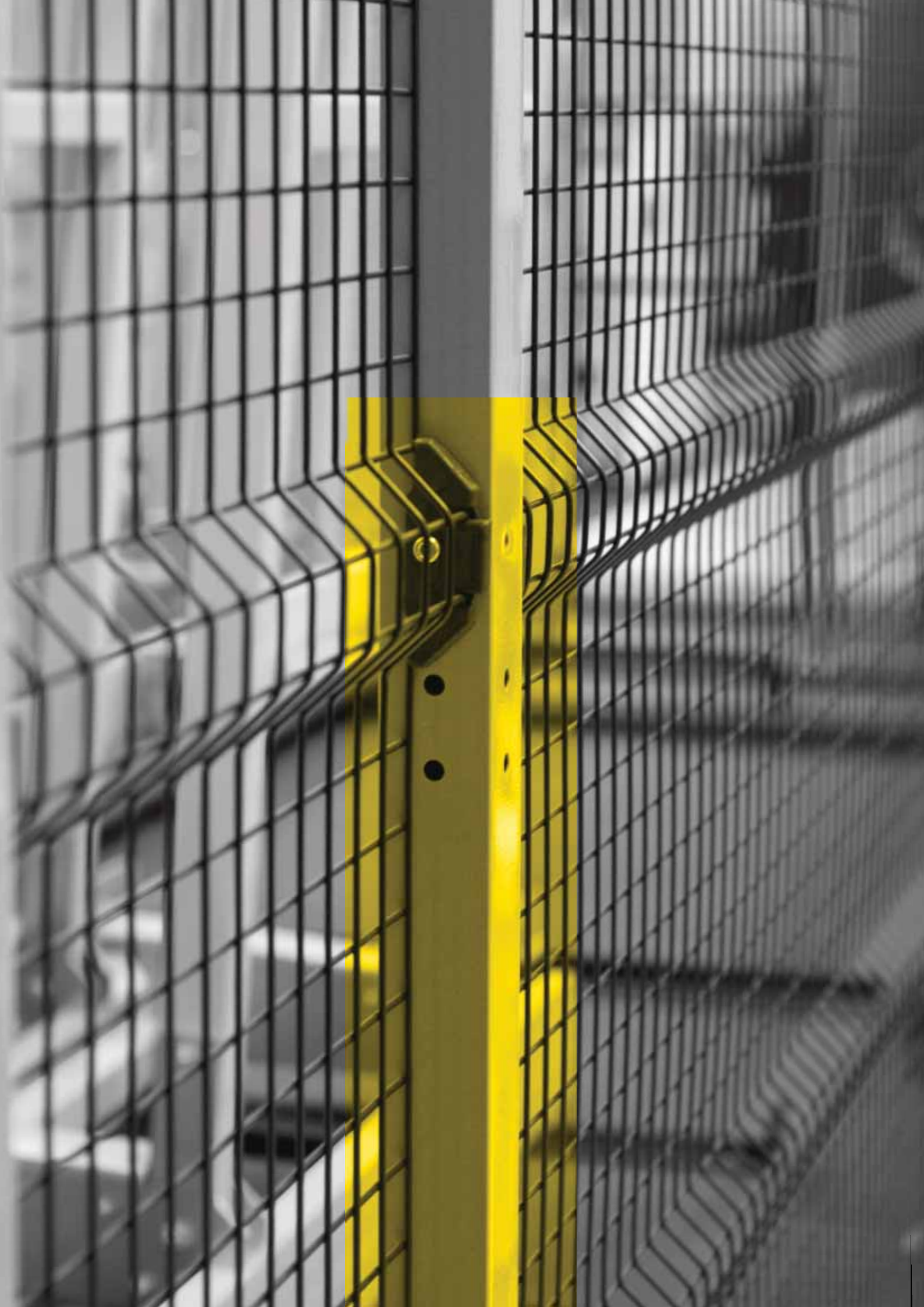

MODULA

Modula posts provide a post-to-panel fixing system with a plate and retained fastening. This system is manufactured in conformity with UNI EN ISO 14120, EN 12100 standards, Machinery Directive 2006/42/CE. The post is fitted with a hook system called Close up which facilitates assembly and standard holes to fix panels and other accessories.

MODULA FIXING SYSTEM EUROPEAN PATENT N° 3708742



**HOOK SYSTEM
CLOSE UP**

BASE, TUBULAR AND FLOOR FITTING

WELDED BASE



☑ **60x60** 4 mechanic zinc coated M8 steel plugs

PLATE SIZE: 192x100mm

ADJUSTABLE BASE



☑ **60x60** 4 mechanic zinc coated M8 steel plugs

Height adjusting: 25mm

PLATE SIZE: 192x100 mm

COMPATIBILITY

Modula Panels

COLOURS (RAL)

Panels undergo epoxy coating.



9005



1018



7035

Other colours available upon request

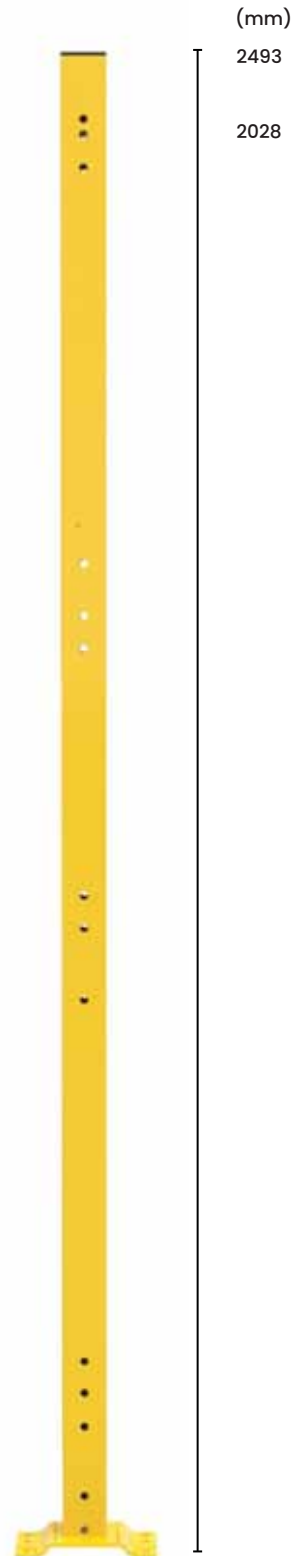

(mm)

2493

2028

Over the years Accessafe has designed a range of accessories able to solve problems which may occur during assembly or to complete the fencing systems with sensors and support components.

01. WIDTH CUTTING KIT

This accessory is used to resize the panel. Available as width re-sizing kit.

COMPATIBILITY

Framed guard systems

02. HEIGHT CUTTING KIT

This accessory is used to resize the panel. Available as height re-sizing kit.

COMPATIBILITY

Framed guard systems

03. PANEL TOEBOARD KIT

This accessory is used to cover the opening between panel and floor.

COMPATIBILITY

Framed guard systems

04. HORIZONTAL CONNECTION KIT

This accessory is used to join panels. Available as horizontal connection kit.

COMPATIBILITY

Framed guard systems

05. REINFORCED HORIZONTAL CONNECTION KIT

This accessory is used to join panels. Available as horizontal connection kit with braces.

COMPATIBILITY

Framed guard systems

06. VERTICAL CONNECTION KIT

This accessory is used to join panels. Available as vertical connection kit with braces.

COMPATIBILITY

Framed guard systems

07. ROOF CONNECTION KIT

This accessory is used to connect panels. It can be used as a kit to connect horizontal panels to vertical panels.

COMPATIBILITY

Framed guard systems

08. PANEL TO WALL CONNECTION KIT

This accessory is used to connect panels. It can be used as a kit to connect panels to the wall.

COMPATIBILITY

Framed guard systems

09. QUICK FEET KIT

Quick system for framed panels 20x20mm is used to mount panels without posts with plugging option.

COMPATIBILITY

Framed guard systems

10. FLEX FEET KIT

Flex system for panels with 20x20mm frames can be used. In absence of posts, they can come with a plugging system or a mobile option on rollers.

COMPATIBILITY

Framed guard systems

01 WIDTH CUTTING KIT



02 HEIGHT CUTTING KIT



03 PANEL TOEBOARD KIT



04 HORIZONTAL CONNECTION KIT

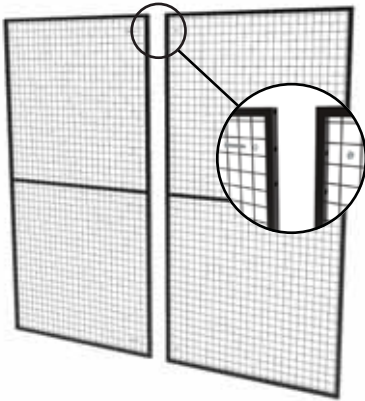

05 REINFORCED HORIZONTAL CONNECTION KIT

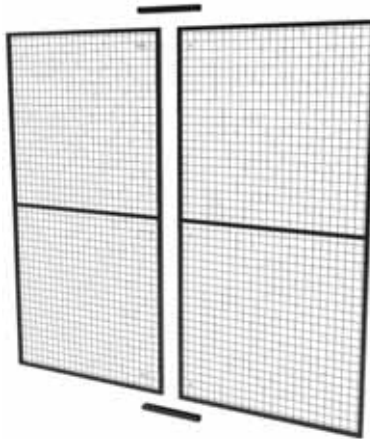

06 VERTICAL CONNECTION KIT

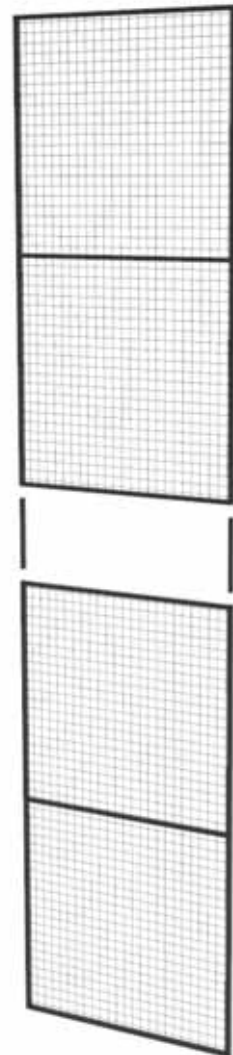

07 ROOF CONNECTION KIT

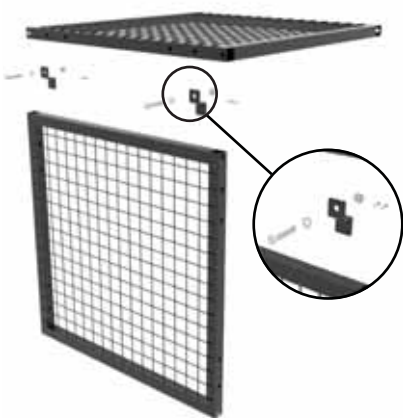

08 PANEL TO WALL CONNECTION KIT

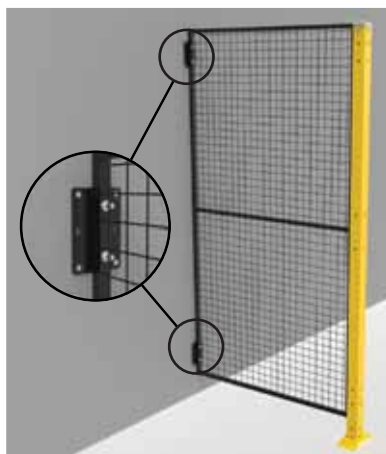

09 QUICK FEET KIT

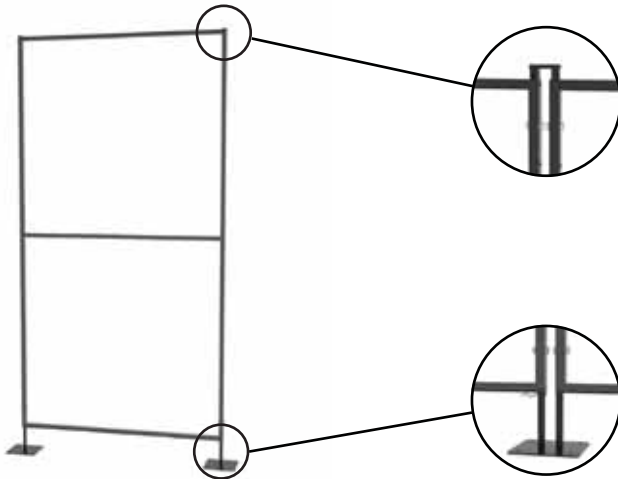

ACCESSORY FOR IN-LINE CONNECTIONS
Added to kit upon request to move panels

ACCESSORY FOR IN-LINE CONNECTIONS
Added to kit upon request to move panels

10 FLEX FEET KIT

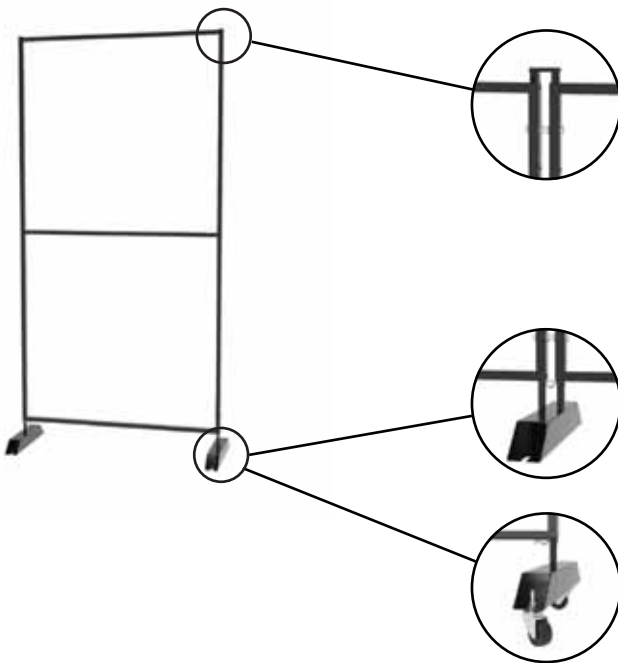

ACCESSORY FOR IN-LINE CONNECTIONS
Added to kit upon request to move panels

ACCESSORY FOR IN-LINE CONNECTIONS
Added to kit upon request to move panels

ACCESSORY FOR IN-LINE OR TERMINAL CONNECTIONS
Added to kit upon request to move panels





Barcode
D4
2010



Grid pattern
Safety information
QR code

5

4

CEMEX



Over the years Accessafe has designed a range of accessories able to solve problems which may occur during assembly or to complete the fencing systems with sensors and support components.

01. META CAP FIXING KIT FOR HEIGHT DROPS

This accessory is used to fix Meta posts to panels when height drops occur. The cap type is used when there is no in-line restart.

COMPATIBILITY

Framed guard systems

02. META IN-LINE FIXING KIT FOR HEIGHT DROPS

This accessory is used to fix Meta posts to panels when height drops occur. The in-line type is used when panels re-start in-line.

COMPATIBILITY

Framed guard systems

03. META ANGULAR FIXING KIT FOR HEIGHT DROPS

This accessory is used to fix Meta posts to panels when height drops occur. The angular type is used when panels re-start by forming a 90° angle.

COMPATIBILITY

Framed guard systems

04. GROUNDING KIT

This is a mandatory accessory to implement a equipotential bonding circuit for grounding systems as per IEC 60204 standard.

COMPATIBILITY

Framed guard systems

05. ≠ 90° META FIXING KIT

This accessory is used to allow panel vertical connection when there is a post restart at an ≠ 90° angle.

COMPATIBILITY

Framed guard systems

06. VITERIA FIXING CAP KIT

This accessory provides an extra captive screw to improve META posts rigidity. It is used to fix panels vertically to the posts, when no in-line panel restart occurs. It is recommended to increase stability at heights above 2320 mm.

COMPATIBILITY

Framed guard systems

07. IN-LINE VITERIA FIXING KIT

This accessory provides an extra captive screw to improve META posts rigidity. It is used to fix panels vertically to the posts, when in-line panel restart occurs.

COMPATIBILITY

Framed guard systems

08. ANGULAR VITERIA FIXING KIT

This accessory provides an extra captive screw to improve META posts rigidity. It is used to fix panels vertically to the posts, when 90° angle panel restart occurs.

COMPATIBILITY

Framed guard systems

09. GASKET KIT

Rubber accessory used to cover the gap between post and panel, mainly for metal sheet panels, when protection of welding workstation is required in order to prevent any light infiltration.

COMPATIBILITY

Framed guard systems



01 META CAP
FIXING KIT
FOR HEIGHT DROPS



02 META IN-LINE
FIXING KIT
FOR HEIGHT DROPS



03 META ANGULAR
FIXING KIT FOR
HEIGHT DROPS



04 GROUNDING
KIT

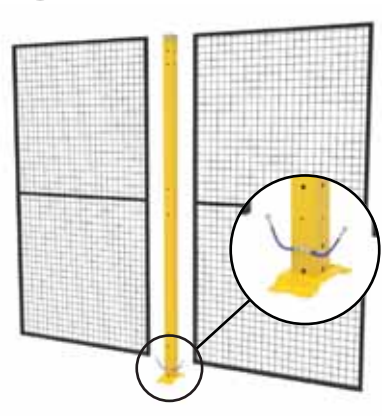

05 ≠ 90° META
FIXING KIT



06 VITERIA FIXING CAP
KIT

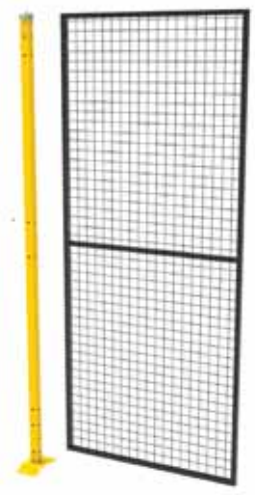

07 VITERIA
IN-LINE FIXING
KIT



08 VITERIA
ANGULAR FIXING
KIT

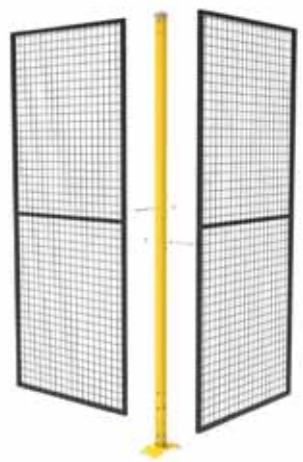

09 GASKET
KIT



ACCESSORIES FOR FRAMELESS SYSTEMS AND MODULA POSTS

Over the years Accessafe has designed a range of accessories able to solve problems which may occur during assembly or to complete the fencing systems with sensors and support components.

01. MODULA UNIVERSAL FIXING KIT

This accessory is fitted with a retained fastening to fix the panel to Modula posts. It is composed by a couple of plates.

COMPATIBILITY

Frameless protection systems

02. MODULA $\neq 90^\circ$ FIXING KIT FOR 2028mm POSTS

This accessory is made of 4 plates which are used to fix the panel to the Modula post by means of a retained fastening. This kit is used when there are angles $\neq 90^\circ$ and 2028 mm high posts.

COMPATIBILITY

Frameless protection systems

03. MODULA $\neq 90^\circ$ FIXING KIT FOR 2493mm POSTS

This accessory is made of 5 plates which are used to fix the panel to the Modula post by means of a retained fastening. This kit is used when there are angles $\neq 90^\circ$ and 2028 mm high posts.

COMPATIBILITY

Frameless protection systems

04. MODULA MESH CONNECTION KIT

This accessory is used to connect panels.

COMPATIBILITY

Frameless protection systems

05. MODULA MESH TO WALL CONNECTION KIT

This accessory is used to connect panels to the wall.

COMPATIBILITY

Frameless protection systems

01 MODULA UNIVERSAL
FIXING KIT



02 MODULA \neq 90° FIXING KIT
FOR 2028mm POSTS

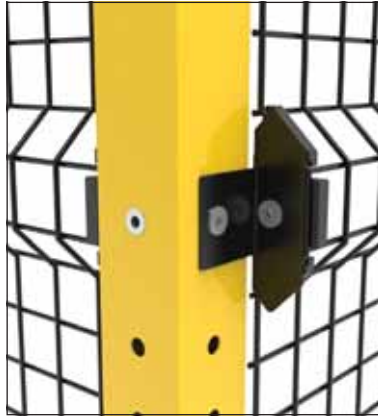

03 MODULA \neq 90° FIXING KIT
FOR 2493mm POSTS



04 MODULA MESH
CONNECTION KIT



05 MODULA MESH TO WALL
CONNECTION KIT





Over the years Accessafe has designed a range of accessories able to solve problems which may occur during assembly or to complete the fencing systems with sensors and support components.

01. GASKETS

This accessory is used to cover mesh spikes which may occur when mesh is cut during assembly.

COMPATIBILITY

Framed and frameless guarding systems

02. BRACING

This accessory is used to guarantee stability and it is fitted to posts which carry heavy loads due to movable doors or posts which are positioned in difficult areas.

COMPATIBILITY

Framed and frameless guarding systems

03. PULL AND PUSH PLATE

This accessory is used to fit posts on irregular floors.

COMPATIBILITY

Framed and frameless guarding systems

04. CABLE TROUGH

This accessory is used to install cable troughs on Meta, Viteria or Modula posts.

COMPATIBILITY

Framed and frameless guarding systems

05. FLOOR RAILS

This accessory is complete with a floor rail and rollers for sliding doors.

COMPATIBILITY

Framed and frameless guarding systems

06. ROLLERS

This accessory is used to improve door opening. There are two types of kits: pivoting roller kit, free moving roller which rotates around vertical axle, or sliding roller kit, the roller moves on rails.

COMPATIBILITY

Framed and frameless guarding systems

07. GRID FIXING PLATE

This accessory is used to fix posts on grids (max grid thickness 60 mm).

COMPATIBILITY

Framed and frameless guarding systems

08. HANDLES

Extra accessory for door panels.

COMPATIBILITY

Framed and frameless guarding systems



01 GASKETS



02 BRACING



03 PUSH AND PULL PLATE



04 CABLE TROUGH



05 FLOOR RAIL



06 ROLLERS



07 GRID FIXING PLATE



08 HANDLES





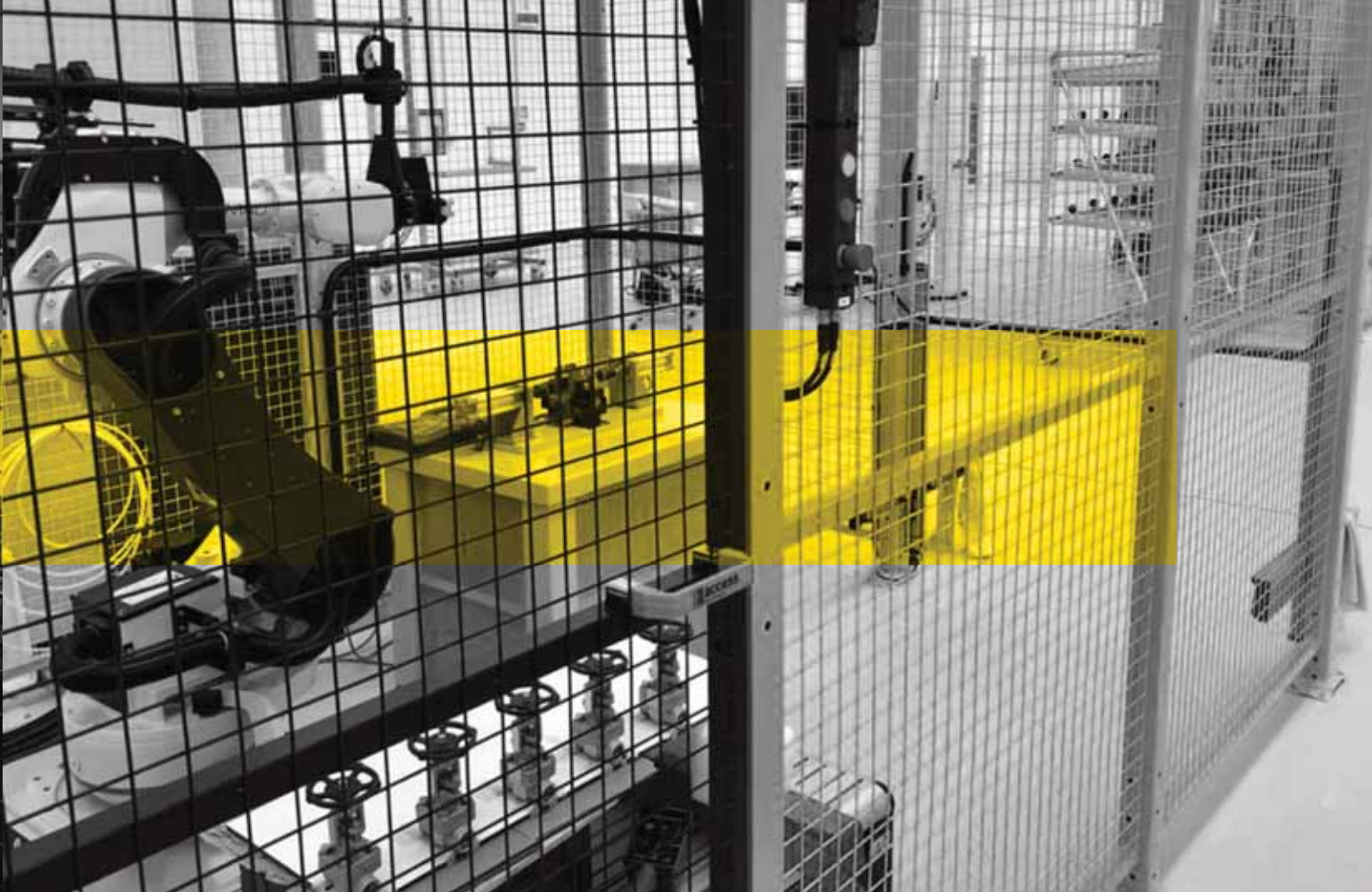

HINGED DOORS

Accesssafe hinged doors follow the “door-in-a-box” concept and come with posts and accessories. Panels need to be purchased separately.

Upon request doors can be equipped with different type of lock housings in order to fit the preferred locking system. For this purpose, Accesssafe offers a wide range of dedicated or universal housings which allow to install safety switches of the main international brands.

DOOR TYPE

SINGLE HINGED
DOUBLE HINGED

COMPATIBILITY

All doors, according to selected type, are compatible either with framed panel guard systems and Meta or Viteria posts or Modula frameless panels and posts.

TRANSOM



WITH



WITHOUT

COLOURS (RAL)

Doors undergo epoxy coating

- 9005
- 1018
- 7035

Other colours available upon request

SINGLE HINGED DOOR

Single hinged doors, with zinc coated iron hinges. These doors are realized with META or VITERIA posts and the door can be built using any framed panel in the Accessafe range. For guard systems with MODULA posts, doors can be built using only the QUADRA range 30x30mm.

The door can be pre assembled at our factory, or it can be supplied as Door in a Box, to be assembled on site. Posts and assembly accessories are supplied but door panels need to be purchased separately. All doors have floor fixing plugs and include UNI EN ISO 14120 fastening bolts.



LOCKING SYSTEMS



GAMMA



DOUBLE BALL CATCH

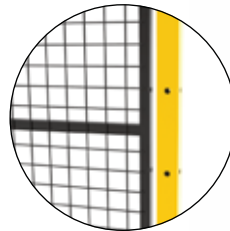

CLOSING NOT REQUIRED

BASE, TUBULAR AND FLOOR FITTING

WELDED BASE



☑ **40x40** 2 M8 galvanized steel mechanic plugs

☑ **60x60** 4 M8 galvanized steel mechanic plugs

PLATE SIZE: 192x100mm

ADJUSTABLE BASE



☑ **40x40** 2 M8 galvanized steel mechanic plugs

Height setting: 18mm

PLATE SIZE: 35x155mm



☑ **60x60** 4 M8 galvanized steel mechanic plugs

Height setting: 25mm

PLATE SIZE: 192x100mm



☑ **80x80** 4 M8 galvanized steel mechanic plugs

PLATE SIZE: 200x200mm



☑ **80x80** 4 M8 galvanized steel mechanic plugs

Height setting: 25mm

PLATE SIZE: 200x200mm



☑ **80x80** 4 M8 galvanized steel mechanic plugs

Height setting: 40mm

PLATE SIZE: 200x200mm

COMPATIBILITY

META E VITERIA POSTS

Guard systems with META and VITERIA posts.

ALL POSTS

Guard systems with META, VITERIA and MODULA posts.

VITERIA POSTS

Guard systems VITERIA posts.

DOUBLE HINGED DOOR

Single hinged doors, with zinc coated iron hinges. These doors are realized with META or VITERIA posts and the door can be built using any framed panel in the Accesssafe range. For guard systems with MODULA posts, doors can be built using only the QUADRA range 30x30mm.

The door can be pre assembled at our factory, or it can be supplied as Door in a Box, to be assembled on site. Posts and assembly accessories are supplied but door panels need to be purchased separately. All doors have floor fixing plugs and include UNI EN ISO 14120 fastening bolts.



LOCKING SYSTEMS

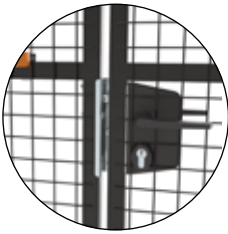

GAMMA



BARREL BOLT

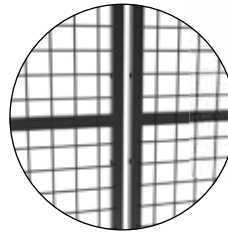

CLOSING NOT REQUIRED

BASE, TUBULAR AND FLOOR FITTING

WELDED BASE



☑ **40x40** 2 M8 galvanized steel mechanic plugs

☑ **60x60** 4 M8 galvanized steel mechanic plugs

PLATE SIZE: 192x100mm

ADJUSTABLE BASE



☑ **40x40** 2 M8 galvanized steel mechanic plugs

Height setting: 18mm

PLATE SIZE: 35x155mm



☑ **60x60** 4 M8 galvanized steel mechanic plugs

Height setting: 25mm

PLATE SIZE: 192x100mm



☑ **80x80** 4 M8 galvanized steel mechanic plugs

PLATE SIZE: 200x200mm



☑ **80x80** 4 M8 galvanized steel mechanic plugs

Height setting: 25mm

PLATE SIZE: 200x200mm



☑ **80x80** 4 M8 galvanized steel mechanic plugs

Height setting: 40mm

PLATE SIZE: 200x200mm

COMPATIBILITY

META E VITERIA POSTS

Guard systems with META and VITERIA posts.

ALL POSTS

Guard systems with META, VITERIA and MODULA posts.

VITERIA POSTS

Guard systems VITERIA posts.



SINGLE LEAF

DOUBLE LEAF

DESCRIPTION

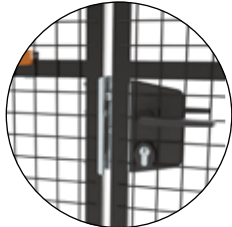

01. GAMMA

High quality lock with aluminum housing and stainless steel mechanism. It is supplied with a set of 2 anodized aluminum handles. Key lock is available upon request.

COMPATIBILITY

Dedicated panels 30x30mm tubular

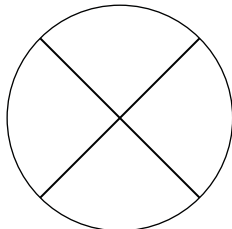
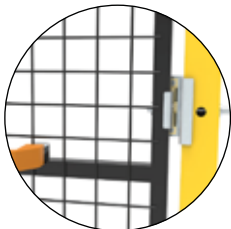

02. LATCH

Brass mechanic groove and tongue lock.

COMPATIBILITY

All framed panels

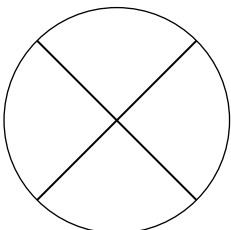

03. BARREL BOLT

Mechanic lock with horizontal sliding barrel bolt with handle included.

COMPATIBILITY

All framed panels

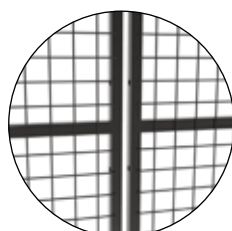
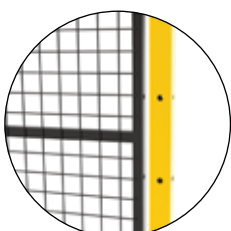

04. CLOSING NOT REQUIRED

Lock-free system for optional fitting of accessories such as a safety push bar or safety electronic locks.

COMPATIBILITY

All framed panels



Doors are one of the most used guard system elements, for this reason great attention is dedicated to their components and quality.

01. PANIC BAR

Panic bar locking systems can be perfectly integrated to Accesssafe doors. This type of locking system is easy to use and limits access from the outside to the inside and at the same time allows for emergency exit from inside. It is compatible with panels up to 1200mm.

COMPATIBILITY

Hinged doors

02. PUSH PAD

Panic push pad locking systems can be perfectly integrated to Accesssafe doors. This type of locking system is easy to use as it limits access from the outside to the inside and at the same time allows for emergency exit from inside.

COMPATIBILITY

Hinged doors

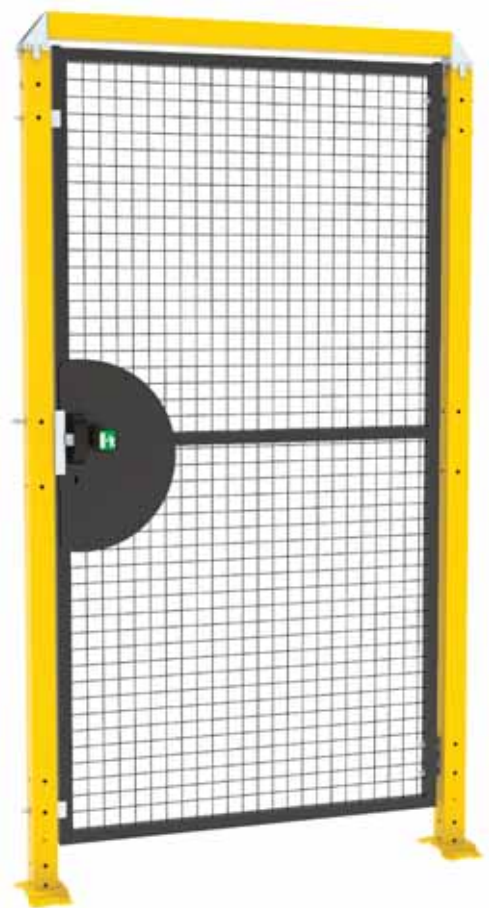



HELP HELP



SLIDING DOORS



Accessafe sliding doors follow the “door-in-a-box” concept and come with posts and accessories. Panels need to be purchased separately.

Upon request doors can be equipped with different type of lock housings in order to fit the preferred locking system. For this purpose, Accessafe offers a wide range of dedicated or universal housings which allow to install safety switches of the main international brands.

COLOURS (RAL)

Doors undergo epoxy coating



9005



1018

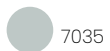

7035

Other colours available upon request

DOOR TYPES

UPPER BINARY

Single opening
Single and opposing opening

BOTTOM TRACK

Single opening
Single and opposing opening

ROLLER BEARINGS

Single opening
Single and opposing opening

COMPATIBILITY

All doors, according to selected type, are compatible either with framed panel guard systems and Meta or Viteria posts or Modula frameless panels and posts.

UPPER BINARY

SINGLE OPENING

The upper binary sliding door, featuring an extra-strong aluminum rail fitted to the posts with special quills can be built using any of Accessafe framed panels. This door can be pre-assembled in the factory or ordered as Door in a Box. Accessories and posts for assembly are supplied whereas the door panels need to be purchased separately. All doors are provided with floor fixing plugs and captive bolts as per UNI EN ISO14120.



LOCKING SYSTEMS



GAMMA



DOUBLE BALL CATCH

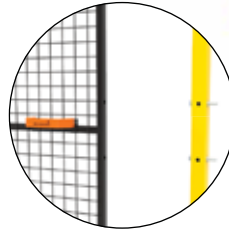

CLOSING NOT REQUIRED

BASE, TUBULAR AND FLOOR FITTING

WELDED BASE



☑ **40x40** 2 M8 galvanized steel mechanic plugs

☑ **60x60** 4 M8 galvanized steel mechanic plugs

PLATE SIZE: 192x100mm

ADJUSTABLE BASE



☑ **40x40** 2 M8 galvanized steel mechanic plugs

Height setting: 18mm

PLATE SIZE: 35x155mm



☑ **60x60** 4 M8 galvanized steel mechanic plugs

Height setting: 25mm

PLATE SIZE: 192x100mm



☑ **80x80** 4 M8 galvanized steel mechanic plugs

PLATE SIZE: 200x200mm



☑ **80x80** 4 M8 galvanized steel mechanic plugs

Height setting: 25mm

PLATE SIZE: 200x200mm



☑ **80x80** 4 M8 galvanized steel mechanic plugs

Height setting: 40mm

PLATE SIZE: 200x200mm

COMPATIBILITY

META E VITERIA POSTS

Guard systems with META and VITERIA posts.

ALL POSTS

Guard systems with META, VITERIA and MODULA posts.

VITERIA POSTS

Guard systems VITERIA posts.

UPPER BINARY

SINGLE AND OPPOSING OPENING

The upper binary sliding door, featuring an extra-strong aluminum binary fitted to the posts with special quills, can be built using any of Accessafe framed panels. This door can be pre-assembled in the factory or ordered as Door in a Box. Accessories and posts for assembly are supplied whereas the door panels need to be purchased separately. All doors are provided with floor fixing plugs and captive bolts as per UNI EN ISO14120.



LOCKING SYSTEMS



GAMMA

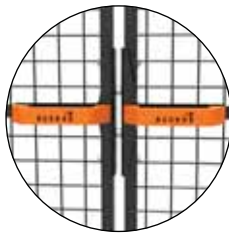

MAGNETIC

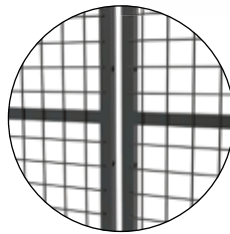

CLOSING NOT REQUIRED

BASE, TUBULAR AND FLOOR FITTING

WELDED BASE



☑ **40x40** 2 M8 galvanized steel mechanic plugs

☑ **60x60** 4 M8 galvanized steel mechanic plugs

PLATE SIZE: 192x100mm

ADJUSTABLE BASE



☑ **40x40** 2 M8 galvanized steel mechanic plugs

Height setting: 18mm

PLATE SIZE: 35x155mm



☑ **60x60** 4 M8 galvanized steel mechanic plugs

Height setting: 25mm

PLATE SIZE: 192x100mm



☑ **80x80** 4 M8 galvanized steel mechanic plugs

PLATE SIZE: 200x200mm



☑ **80x80** 4 M8 galvanized steel mechanic plugs

Height setting: 25mm

PLATE SIZE: 200x200mm



☑ **80x80** 4 M8 galvanized steel mechanic plugs

Height setting: 40mm

PLATE SIZE: 200x200mm

COMPATIBILITY

META E VITERIA POSTS

Guard systems with META and VITERIA posts.

ALL POSTS

Guard systems with META, VITERIA and MODULA posts.

VITERIA POSTS

Guard systems VITERIA posts.

BOTTOM TRACK

SINGLE OPENING

The sliding door with bottom track, featuring a zinc stainless steel rail with omega profile and fixed to the floor with special plugs, with ogives which get the door to slide, can be built using any of Accessafe framed panels. The door can be ordered as Door in a Box to be assembled on-site. Accessories and posts for assembly are supplied whereas the door panels need to be purchased separately in T30 version. All doors are provided with floor fixing plugs and captive bolts as per UNI EN ISO14120.



LOCKING SYSTEMS



GAMMA

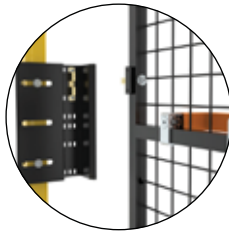

DOUBLE BALL CATCH

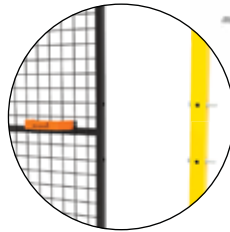

CLOSING NOT REQUIRED

BASE, TUBULAR AND FLOOR FITTING

WELDED BASE



☑ **40x40** 2 M8 galvanized steel mechanic plugs

☑ **60x60** 4 M8 galvanized steel mechanic plugs

PLATE SIZE: 192x100mm

ADJUSTABLE BASE



☑ **40x40** 2 M8 galvanized steel mechanic plugs

Height setting: 18mm

PLATE SIZE: 35x155mm



☑ **60x60** 4 M8 galvanized steel mechanic plugs

Height setting: 25mm

PLATE SIZE: 192x100mm



☑ **80x80** 4 M8 galvanized steel mechanic plugs

PLATE SIZE: 200x200mm



☑ **80x80** 4 M8 galvanized steel mechanic plugs

Height setting: 25mm

PLATE SIZE: 200x200mm



☑ **80x80** 4 M8 galvanized steel mechanic plugs

Height setting: 40mm

PLATE SIZE: 200x200mm

COMPATIBILITY

META E VITERIA POSTS

Guard systems with META and VITERIA posts.

ALL POSTS

Guard systems with META, VITERIA and MODULA posts.

VITERIA POSTS

Guard systems VITERIA posts.

BOTTOM TRACK

SINGLE AND OPPOSING OPENING

The sliding door with bottom track, featuring a zinc stainless steel rail with omega profile and fixed to the floor with special plugs, with ogives which get the door to slide, can be built using any of Accessafe framed panels. The door can be ordered as Door in a Box to be assembled on-site. Accessories and posts for assembly are supplied whereas the door panels need to be purchased separately in T30 version. All doors are provided with floor fixing plugs and captive bolts as per UNI EN ISO14120.



LOCKING SYSTEMS



GAMMA

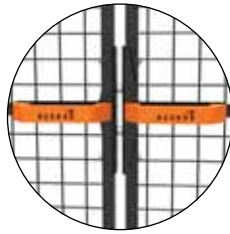

MAGNETIC

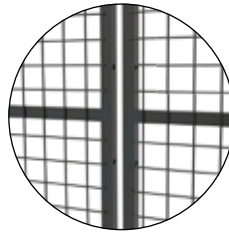

CLOSING NOT REQUIRED

BASE, TUBULAR AND FLOOR FITTING

WELDED BASE



☑ **40x40** 2 M8 galvanized steel mechanic plugs

☑ **60x60** 4 M8 galvanized steel mechanic plugs

PLATE SIZE: 192x100mm

ADJUSTABLE BASE

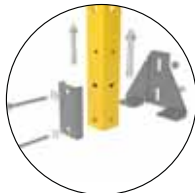

☑ **40x40** 2 M8 galvanized steel mechanic plugs

Height setting: 18mm

PLATE SIZE: 35x155mm



☑ **60x60** 4 M8 galvanized steel mechanic plugs

Height setting: 25mm

PLATE SIZE: 192x100mm



☑ **80x80** 4 M8 galvanized steel mechanic plugs

PLATE SIZE: 200x200mm



☑ **80x80** 4 M8 galvanized steel mechanic plugs

Height setting: 25mm

PLATE SIZE: 200x200mm



☑ **80x80** 4 M8 galvanized steel mechanic plugs

Height setting: 40mm

PLATE SIZE: 200x200mm

COMPATIBILITY

META E VITERIA POSTS

Guard systems with META and VITERIA posts.

ALL POSTS

Guard systems with META, VITERIA and MODULA posts.

VITERIA POSTS

Guard systems VITERIA posts.

ROLLER BEARINGS

SINGLE OPENING

The single opening roller-bearing sliding door, featuring ogives which get the door to slide, can be built using any of Accesssafe framed panels. The door can be ordered as Door in a Box to be assembled on-site. Accessories and posts for assembly are supplied whereas the door panels need to be purchased separately in T30 version. All doors are provided with floor fixing plugs and captive bolts as per UNI EN ISO14120.



LOCKING SYSTEMS



GAMMA



DOUBLE BALL CATCH

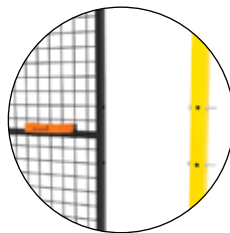

CLOSING NOT REQUIRED

BASE, TUBULAR AND FLOOR FITTING

WELDED BASE



60x60 4 M8 galvanized steel mechanic plugs

PLATE SIZE: 192x100mm

ADJUSTABLE BASE



60x60 4 M8 galvanized steel mechanic plugs

Height setting: 25mm

PLATE SIZE: 192x100mm

COMPATIBILITY

ALL POSTS

Guard systems with META, VITERIA and MODULA posts.

ROLLER BEARINGS

SINGLE AND OPPOSING OPENING

The single opening roller-bearing sliding door with opposing opening, featuring ogives which get the door to slide, can be built using any of Accesssafe framed panels. The door can be ordered as Door in a Box to be assembled on-site. Accessories and posts for assembly are supplied whereas the door panels need to be purchased separately in T30 version. All doors are provided with floor fixing plugs and captive bolts as per UNI EN ISO14120.



LOCKING SYSTEMS



GAMMA

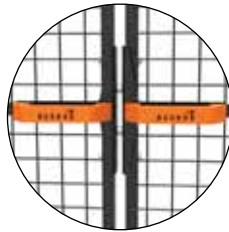

MAGNETIC

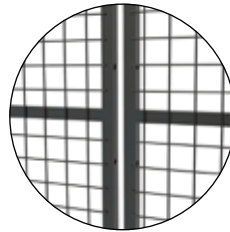

CLOSING NOT REQUIRED

BASE, TUBULAR AND FLOOR FITTING

WELDED BASE



60x60 4 M8 galvanized steel mechanic plugs

PLATE SIZE: 192x100mm

ADJUSTABLE BASE



60x60 4 M8 galvanized steel mechanic plugs

Height setting: 25mm

PLATE SIZE: 192x100mm

COMPATIBILITY

ALL POSTS

Guard systems with META, VITERIA and MODULA posts.



SLIDING SINGLE OPENING

SLIDING SINGLE AND OPPOSING OPENING

DESCRIPTION



01. GAMMA

High quality lock with aluminum housing and stainless steel mechanism. It is supplied with a set of 2 anodized aluminum handles. Key lock is available upon request.

COMPATIBILITY

Dedicated panels 30x30mm tubular

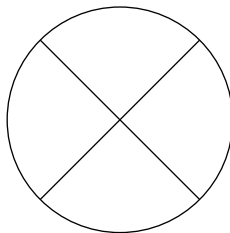
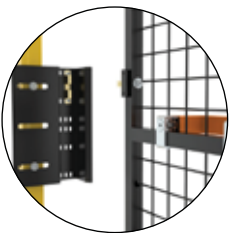

02. LATCH

Brass mechanic groove and tongue lock.

COMPATIBILITY

All framed panels

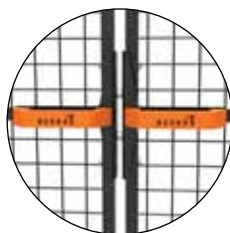
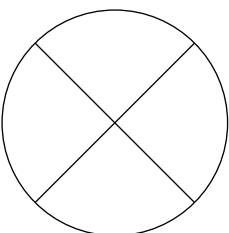

03. MAGNETIC

Magnetic stop

COMPATIBILITY

All framed panels

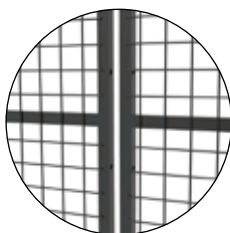
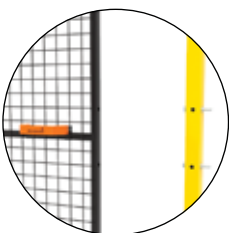

04. CLOSING NOT REQUIRED

Lock-free system for optional fitting of accessories such as a safety push bar or safety electronic locks.

COMPATIBILITY

All framed panels



Over the years Accesssafe has designed a range of accessories able to solve problems which may occur during assembly or to complete the fencing systems with sensors and support support components.

01. HANDLE KIT

Optional accessories for door panel.

COMPATIBILITY

Framed and frameless guarding systems.

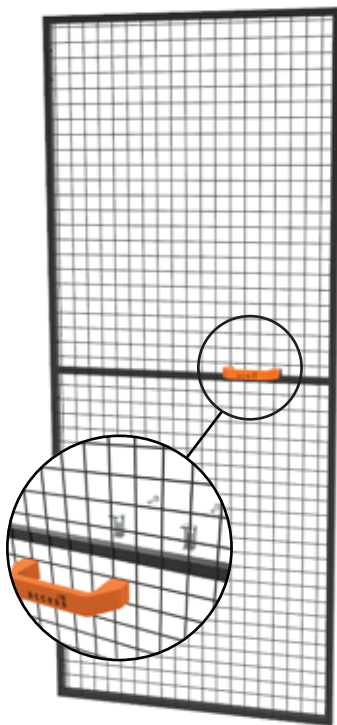

02. ROLLER KIT

This accessory is used to improve door opening. The pivoting roller is free moving and rotates around vertical axle.

COMPATIBILITY

Framed and frameless guarding systems.

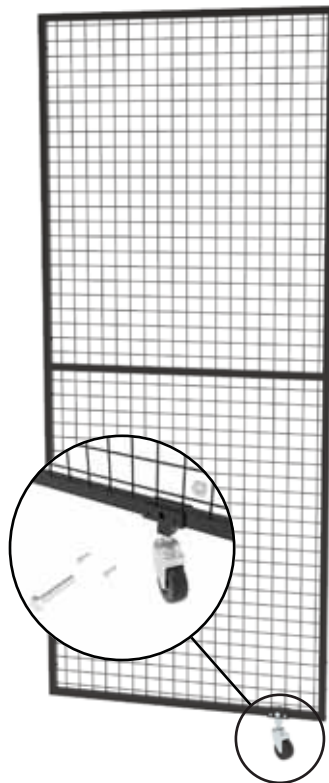

03. DOOR TOEBOARD KIT

This accessory is used to cover the gap between the floor and the door panel.

COMPATIBILITY

Framed and frameless guarding systems.





Over the years Accessafe has designed a range of accessories able to solve problems which may occur during assembly or to complete the fencing systems with sensors and support support components.

EUCHNER

MICROSWITCH

Euchner MGB
 Euchner MGB
 Euchner MGB
 Euchner MGB
 Euchner MGB
 Euchner MGB
 Euchner CES AP/AR
 Euchner CES AP/AR
 Euchner CES AP/AR
 Euchner TP/STP
 Euchner TP/STP
 Euchner CTP
 Euchner NP

DOOR COMPATIBILITY

Single leaf hinged door | 40-60 post | 20 frame
 Single leaf hinged door | 40-60 post | 30 frame
 Single leaf hinged door | 80 post | 20-30 frame
 Double leaf hinged door | 20-30 frame
 Single leaf sliding door upper binary | 40-60-80 posts | 20-30 frame
 Single leaf sliding door opposing opening | 20-30 frame
 Single leaf hinged door | 40-60 post | 20-30 frame
 Double leaf hinged door | 20-30 frame
 Single leaf sliding door | 40-60 post | 20-30 frame
 Single leaf sliding door | 40-60 post | 20-30 frame
 Double leaf hinged door | 20-30 frame
 Single leaf hinged door | 40-60 post | 20-30 frame
 Single leaf hinged door | 40-60 post | 20-30 frame

CODE

VFKA.000138
 VFKA.000139
 VFKA.000140
 VFKA.000141
 VFKA.000142
 VFKA.000143
 VFKA.000153
 VFKA.000154
 VFKA.000155
 VFKA.000157
 VFKA.000158
 VFKA.000159
 VFKA.000182

SCHMERSAL

MICROSWITCH

Schmersal AZ/AZM200
 Schmersal AZ/AZM200
 Schmersal AZ/AZM200
 Schmersal AZ/AZM200
 Schmersal AZ/AZM200
 Schmersal AZ/AZM200

DOOR COMPATIBILITY

Single leaf hinged door | 40 post | 20-30 frame
 Single leaf hinged door | 60 post | 20-30 frame
 Double leaf hinged door | 20-30 frame
 Upper binary single leaf sliding door
 Double leaf hinged door
 Single leaf hinged door | 40 post | 20-30 frame

CODE

VFKA.000144
 VFKA.000145
 VFKA.000146
 VFKA.000147
 VFKA.000148
 VFKA.000187

PIZZATO

MICROSWITCH

Pizzato FR
 Pizzato FR
 Pizzato FR
 Pizzato FR
 Pizzato FS
 Pizzato NG 2D5/6/7
 Pizzato NG 2D5/6/7
 Pizzato NG 2D5/6/7
 Pizzato NG 2D5/6/7

DOOR COMPATIBILITY

Single leaf hinged door | 40-60 post | 20-30 frame
 Double leaf hinged door | 20-30 frame
 Single leaf sliding door | 40-60-80 post | 20-30 frame
 Single leaf opposing sliding door | 20 frame
 Single leaf hinged door | 40-60 post | 20-30 frame
 Single leaf hinged door | 40-60 post | 20-30 frame
 Double leaf hinged door | 20-30 frame
 Double leaf hinged door | 20-30 frame
 Single leaf sliding door | 40-60posts | 20-30 frame

CODE

VFKA.000149
 VFKA.000150
 VFKA.000151
 VFKA.000152
 VFKA.000156
 VFKA.000160
 VFKA.000161
 VFKA.000162
 VFKA.000163





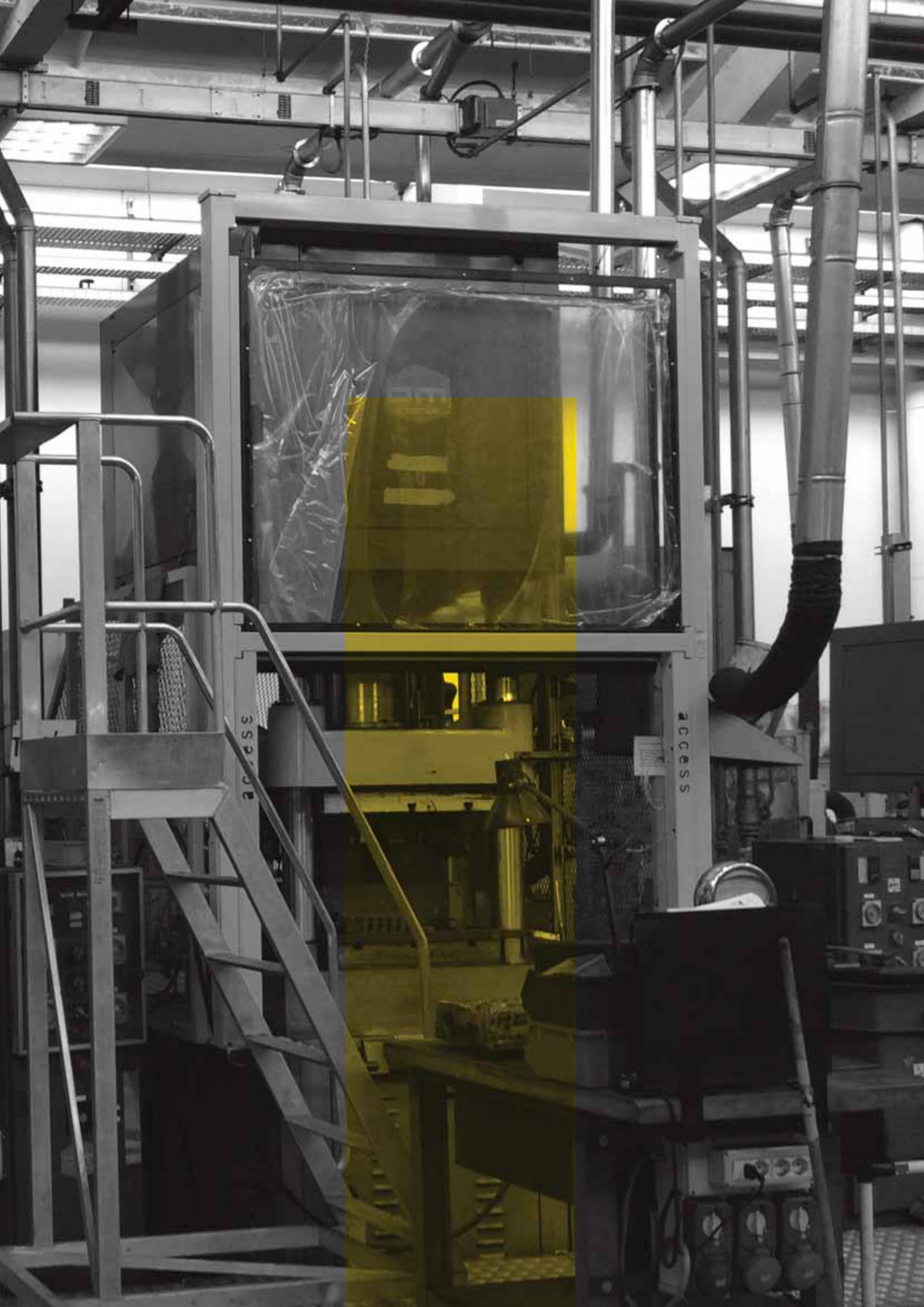



AUTOMATED MOVABLE GUARDS

In industrial processes maintenance and adjustment operations on machinery occur quite frequently, therefore there is an ever growing need for tailor made special access points which allow operators to safely access machinery or for packaging to be automatically unloaded.

Accesssafe special doors, better defined as movable guards, have been designed to guarantee maximum safety and are certified as machinery or "almost machinery" as stated in the Machinery Directive 2006/42/CE. Special dimensions, electro-mechanic or pneumatic motor controls, multi-stage, 2 o 3D conformation, adequate speeds to meet machine production cycle, special colours: all Accesssafe doors are guaranteed up to 10000 cycles and can be fitted with control cabinet, safety control units, inverters for electric engine management, PLC interface-able radio-frequency devices and light signal systems.

AUTOMATED GUARD TYPES

VERTICAL PNEUMATIC

Alpha
Alpha 2

VERTICAL ELECTRIC

Beta
Beta 2

VERTICAL MANUAL

Tau

COLOURS (RAL)

Doors undergo epoxy coating

 9005

 1018

 7035

Other colours available upon request

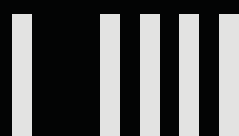

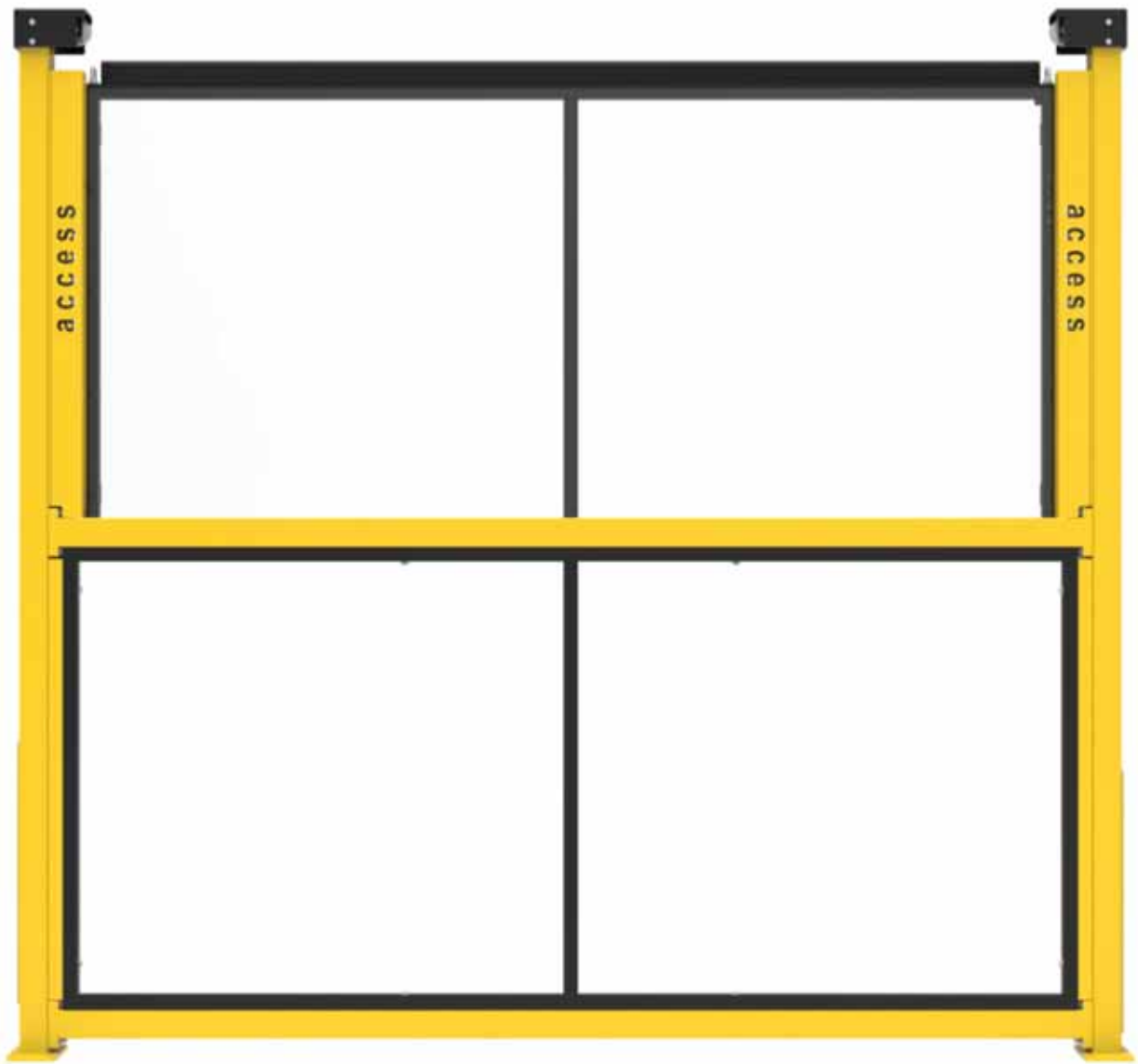

* Pneumatic cylinder is not shown



ALPHA DOOR

VERTICAL MOVABLE GUARD PNEUMATICALLY OPERATED CERTIFIED AS PER MACHINERY DIRECTIVE 2006/42/CE.

Single or double step Alpha vertical door, is operated by a stemless pneumatic cylinder and has a light structure for access point openings up to 2500mm and structural heights up to 3500mm. The presence of an RFID safety limit switch and a sensitive edge on the movable panel guarantee maximum safety in the intervention areas when machine is running and manage automatic opening and closing of movable panels for product loading and unloading. Door sliding is facilitated by an integrated counterbalance system which allows weight unload, and is carried out by cabled linear rails with 5000km run. During the design phase Accessafe engineers evaluate maximum push load applicable to the movement, machine cycle time and maximum opening speed as per workplace safety requirements in order to manufacture tailor made automatic doors with high quality components which guarantee functionality in time.

This door is supplied in a dedicated packaging along with assembly manuals, components technical sheets and CE declaration of incorporation as "almost machinery" as per current norms and standards.

All special doors are tested before going epoxy coating in order to check suitability of all components and compliance with customer's requirements. The video recording of all tests remains in the the technical file for further reference.

STRUCTURAL FEATURES

- Metalwork structure and sliding roller bearing system fitted with counterbalances
- Pneumatic cylinder without variable limit stem and 40mm bore with magnetic position sensor (no safety)
- Sensitive edge with control unit
- Closed door safety limit switch RFID (PLE UNI EN ISO 13859)
- Electrostatic dust coating
- Expansion plug fixing
- CE declaration of incorporation as "almost machinery" as per Machinery Directive 2006/42/CE
- Instruction and maintenance manuals
- Structural calculation

COMPATIBILITY

Alpha doors are compatible with both framed and frameless guard systems. The door can fit a door panel from our RT anti-phalanx range 30x30mm frame and 60x1x3mm mesh. Distance from hazard zone is 20 mm as prescribed by UNI EN ISO 13857 or from our Polycarbonate or Lamiera (metalsheet) range with 0 mm distance from hazard zone as prescribed by UNI EN ISO 13857.

EXTRA OPTIONALS

- Command Panel
- Special fixing system
- CE declaration of conformity
- CEN 60204 Control Panel
- Signalling lamps

BASE, TUBULAR AND FLOOR FITTING

WELDED BASE



☑ **80x60** 4 M12x10 galvanized steel mechanic plugs

PLATE SIZE: 100X150mm
THICKNESS: 10mm

STANDARDS AND NORMS

- Machinery Directive 2006/42/CE
- UNI EN ISO 14119
- UNI EN ISO 14120
- UNI EN ISO 13859
- UNI EN ISO 13850
- UNI EN ISO 13857
- CEI EN 60204-1



* Pneumatic cylinder is not shown



ALPHA DOOR 2

VERTICAL MOVABLE GUARD PNEUMATICALLY OPERATED CERTIFIED AS PER MACHINERY DIRECTIVE 2006/42/CE.

Single or double step Alpha 2 vertical door, is operated by a stemless pneumatic cylinder and has a sturdy structure for access point openings up to 3500mm and structural heights up to 5000mm. The presence of an RFID safety limit switch and a sensitive edge on the movable panel guarantee maximum safety in the intervention areas when machine is running and manage automatic opening and closing of movable panels for product loading and unloading. Door sliding is facilitated by an integrated counterbalance system which allows weight unload, and is carried out by cabled linear rails with 5000km run. During the design phase Accessafe engineers evaluate maximum push load applicable to the movement, machine cycle time and maximum opening speed as per workplace safety requirements in order to manufacture tailor made automatic doors with high quality components which guarantee functionality in time. This door is supplied in a dedicated packaging along with assembly manuals, components technical sheets and CE declaration of incorporation as "almost machinery" as per current norms and standards.

All special doors are tested before going epoxy coating in order to check suitability of all components and compliance with customer's requirements. The video recording of all tests remains in the the technical file for further reference.

STRUCTURAL FEATURES

- Metalwork structure and sliding roller bearing system fitted with counterbalances
- Pneumatic cylinder without variable limit stem and 50-63mm bore with magnetic position sensor; in case of 3000 to 3900mm openings a double cylinder is provided
- Open-Closed door safety limit switch RFID (PLE UNI EN ISO 13859)
- Electrostatic dust coating
- Expansion plug fixing
- CE declaration of incorporation as "almost machinery" as per Machinery Directive 2006/42/CE
- Instruction and maintenance manuals
- Structural calculation

COMPATIBILITY

Alpha doors are compatible with both framed and frameless guard systems. The door fits a door panel from our RT anti-phalanx range 30x30mm frame and 60x11x3mm mesh. Distance from hazard zone is 20 mm as prescribed by UNI EN ISO 13857 or from our Polycarbonate or Lamiera (metalsheet) range with 0 mm distance from hazard zone as prescribed by UNI EN ISO 13857.

EXTRA OPTIONALS

- Command Panel
- Special fixing system
- CE declaration of conformity
- CEN 60204 Control Panel
- Signalling lamps

BASE, TUBULAR AND FLOOR FITTING

WELDED BASE



☑ **100x150** 4 M12x110 galvanized steel mechanic plugs

PLATE SIZE: 250x220mm
THICKNESS: 15mm

STANDARDS AND NORMS

- Machinery Directive 2006/42/CE
- UNI EN ISO 14119
- UNI EN ISO 14120
- UNI EN ISO 13859
- UNI EN ISO 13850
- UNI EN ISO 13857
- CEI EN 60204-1



* 3D door example



BETA DOOR

MOTOR-OPERATED VERTICAL MOVABLE GUARD CERTIFIED AS PER MACHINERY DIRECTIVE 2006/42/CE.

Beta motor-operated vertical door, with single or double step, has a light structure for access dimensions up to 2500mm in width and 3500mm in height. The RFID safety limit switch and the sensitive edge installed on the movable panel guarantee maximum safety when operating in areas with running machinery and manage opening and closing of movable protection guards for product loading/unloading operations.

Door sliding is facilitated by an integrated counterbalance system which allows weight unload, and is carried out by cabled linear rails with 5000km run.

During the design phase Accessafe engineers evaluate maximum push load applicable to the movement, machine cycle time and maximum opening speed as per workplace safety requirements in order to manufacture tailor made automatic doors with high quality components which guarantee functionality in time. This door is supplied in a dedicated packaging along with assembly manuals, components technical sheets and CE declaration of incorporation as "almost machinery" as per current norms and standards.

All special doors are tested before going epoxy coating in order to check suitability of all components and compliance with customer's requirements. The video recording of all tests remains in the the technical file for further reference.

STRUCTURAL FEATURES

- Metalwork structure and sliding roller bearing system fitted with counterbalances
- Electric cylinder without variable speed stem with position sensors
- Sensitive edge with control unit
- Open and closed door safety limit switch RFID (PLE UNI EN ISO 13859)
- Electrostatic dust coating
- Expansion plug fixing
- CE declaration of incorporation as "almost machinery" as per Machinery Directive 2006/42/CE
- Instruction and maintenance manuals
- Structural calculation

COMPATIBILITY

Beta doors are compatible with both framed and frameless guard systems. The door fits a door panel from our RT anti-phalanx range 30x30mm frame and 60x1x3mm mesh. Distance from hazard zone is 20 mm as prescribed by UNI EN ISO 13857 or from our Polycarbonate or Lamiera (metalsheet) range with 0 mm distance from hazard zone as prescribed by UNI EN ISO 13857.

EXTRA OPTIONALS

- Command Panel
- Special fixing system
- CE declaration of conformity
- CEN 60204 Control Panel
- Signalling lamps

BASE, TUBULAR AND FLOOR FITTING

WELDED BASE



☑ **80x60** 4 M12x110 galvanized steel mechanic plugs

PLATE SIZE: 100x150mm
THICKNESS: 15mm

STANDARDS AND NORMS

- Machinery Directive 2006/42/CE
- UNI EN ISO 14119
- UNI EN ISO 14120
- UNI EN ISO 13859
- UNI EN ISO 13850
- UNI EN ISO 13857
- CEI EN 60204-1



* Motor is not shown



BETA DOOR 2

MOTOR-OPERATED VERTICAL MOVABLE GUARD CERTIFIED AS PER MACHINERY DIRECTIVE 2006/42/CE.

Single or double step Beta 2 vertical door, is motor operated and has a light structure for access point openings up to 3500mm and structural heights up to 5000mm. The presence of an RFID safety limit switch and a sensitive edge on the movable panel guarantee maximum safety in the intervention areas when machine is running and manage automatic opening and closing of movable panels for product loading and unloading. Door sliding is facilitated by a self standing gear motor with a transmission unit on shaft to chain fitted with a counterbalance system which allows weight unload, which is carried out by cabled linear roller bearing linear rails with 5000km run.

During the design phase Accesssafe engineers evaluate maximum push load applicable to the movement, machine cycle time and maximum opening speed as per workplace safety requirements in order to manufacture tailor made automatic doors with high quality components which guarantee functionality in time. This door is supplied in a dedicated packaging along with assembly manuals, components technical sheets and CE declaration of incorporation as "almost machinery" as per current norms and standards. All special doors are tested before going epoxy coating in order to check suitability of all components and compliance with customer's requirements. The video recording of all tests remains in the the technical file for further reference.

STRUCTURAL FEATURES

- Metalwork structure and sliding roller bearing system fitted with counterbalances
- Self-breaking gear-motor with adjustable power (speed) with transmission operated by a shaft to chain unit without movement exclusion system
- Sensitive edge with control unit
- Open and closed door safety limit switch RFID (PLE UNI EN ISO 13859)
- Electrostatic dust coating
- Expansion plug fixing
- CE declaration of incorporation as "almost machinery" as per Machinery Directive 2006/42/CE
- Instruction and maintenance manuals
- Structural calculation

COMPATIBILITY

Beta doors are compatible with both framed and frameless guard systems. The door fits a door panel from our RT anti-phalanx range 30x30mm frame and 60x11x3mm mesh. Distance from hazard zone is 20 mm as prescribed by UNI EN ISO 13857 or from our Polycarbonate or Lamiera (metalsheet) range with 0 mm distance from hazard zone as prescribed by UNI EN ISO 13857.

EXTRA OPTIONALS

- Command Panel
- Special fixing system
- CE declaration of conformity
- CEN 60204 Control Panel
- Signalling lamps

BASE, TUBULAR AND FLOOR FITTING

WELDED BASE



☑ **100x150** 4 M12x110 galvanized steel mechanic plugs

PLATE SIZE: 250x220mm
THICKNESS: 15mm

STANDARDS AND NORMS

- Machinery Directive 2006/42/CE
- UNI EN ISO 14119
- UNI EN ISO 14120
- UNI EN ISO 13859
- UNI EN ISO 13850
- UNI EN ISO 13857
- CEI EN 60204-1

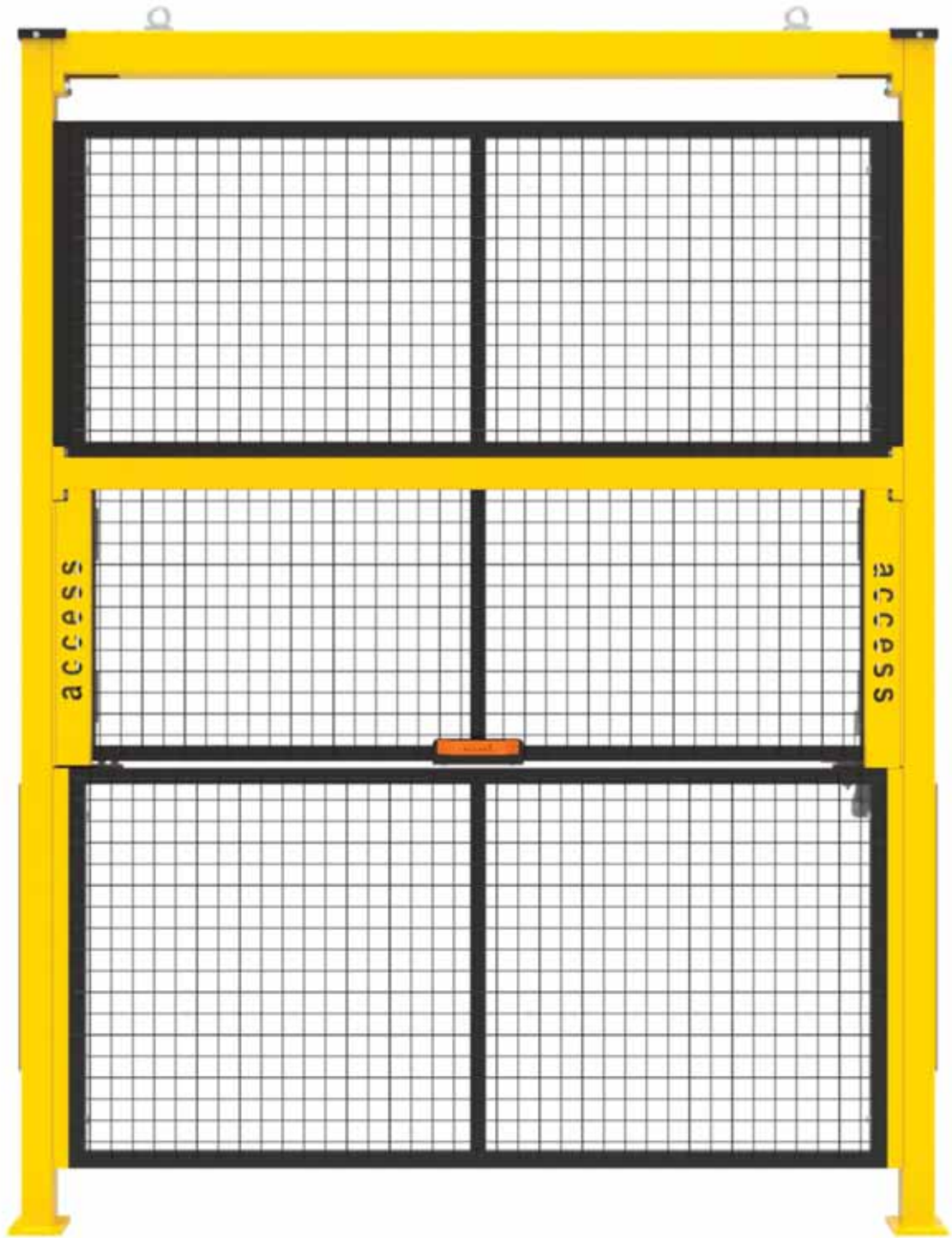



TAU DOOR

MANUALLY OPERATED VERTICAL MOVABLE GUARD

Tau doors are single step manually operated guards with bearing rollers and a light structure which allow access to openings up to 2500mm and structural heights up to 3500mm. This door is suitable to guarantee movement of objects from one area to the next or allows an access point to the machine, in reduced spaces, when the door panel does not have a side or front opening.

In the design phase Accesssafe engineers evaluate maximum component load to the door in order to facilitate door movement thanks to a calibrated counterbalance system.

The door comes in a dedicated packaging with assembly manuals, component technical sheets and it is certified according to UNI EN ISO 14120 "Movable guards".

STRUCTURAL FEATURES

- Metalwork structure with sliding roller bearing system
- Closed door safety limit switch RFID (PLE UNI EN ISO 13859)
- Sensitive edge with control unit
- Electrostatic dust coating
- Expansion plug fixing
- CE certification as per UNI EN ISO 14120
- Instruction and maintenance manuals
- Structural calculation

COMPATIBILITY

Tau doors are compatible with framed and frameless guard systems. The door can fit a 30x30mm framed panel from the RT anti-phalanx range with 60x11x3mm mesh and distance from hazard zone of 120mm as per UNI EN ISO 14120, a panel from the TEC range mesh 15x105mm with 100mm distance from hazard zone, or a panel from our Polycarbonate or Lamiera (Metalsheet) range with 0mm distance from the hazard zone as per UNI EN ISO 13857.

EXTRA OPTIONALS

- Special applications

BASE, TUBULAR AND FLOOR FITTING

WEKDED BASE



☑ **80x60** 4 M12x110 galvanized steel mechanic plugs

PLATE SIZE: 100x150mm
THICKNESS: 15mm

NORMS AND STANDARDS

- Machinery Directive 2006/42/CE
- UNI EN ISO 12100
- UNI EN ISO 14120
- UNI EN ISO 13857







FIELD OF APPLICATION

MACHINE GUARD SYSTEMS

STAINLESS STEEL RANGE INOX

—

Accesssafe INOX (stainless steel) guards are designed according to four main principles: hygiene, adaptability, resistance and safety. These guards are realized in AISI 304 steel which makes them long lasting, easy to clean and sanitize. They are also slot-free, splinter-free and protrusion free which makes them ideal to meet machinery safety requirements in the food, chemical and pharmaceutical industries guaranteeing the high standards of hygiene set by the current UNI EN ISO 1672 standard and the safety requirements mandated by the Machinery Directive 2006/42/CE.

SAFETY DISTANCE

200mm | 100mm

PANEL FRAME

20x20mm | 25x25mm

POST BASE

WELDED

TUBULAR POST

40x40mm

SURFACE TREATMENT

POLISHING

MACHINERY DIRECTIVE & SAFETY NORMS AND REGULATIONS AT THE WORKPLACE

All EC and international norms and regulations the customer must comply to.

—

Machinery Directive 2006 /42 / CE

UNI EN ISO 14120

General requirements for the design, construction of fixed and movable guards.

5.3.2: Guards must be designed to prevent crushing or trapping points with parts of the machinery or with other guards.

5.3.9: Fixed guards must be fixed by systems that can be opened or removed only with tools.

5.3.10: Where possible, guards must be incapable of remaining in place without their fixings.

5.9: Where full visibility of the machine through the guard is needed, suitable materials or mesh panels must be selected in order to guarantee an appropriate open area and appropriate colours to allow visibility.

5.19: RETAINED FASTENING –should removal of fixed guards be liable, for example to allow maintenance, Their fixing systems must remain attached to the guards or to the machinery.

—

UNI EN ISO 13857

Safety distances to prevent free access to machinery hazard zones by higher and/or lower limbs.

UNI EN ISO 13854

Minimum gaps to avoid crushing of parts of the human body.

UNI EN ISO 14119

Interlocking devices associated with guards, Principles for design and selection.

UNI EN ISO 14122-3

Permanent means of access to machinery — Stairs, stepladders and guard-rails.

UNI EN ISO 1672-2

Food processing machinery - Basic concepts , safety requirements.



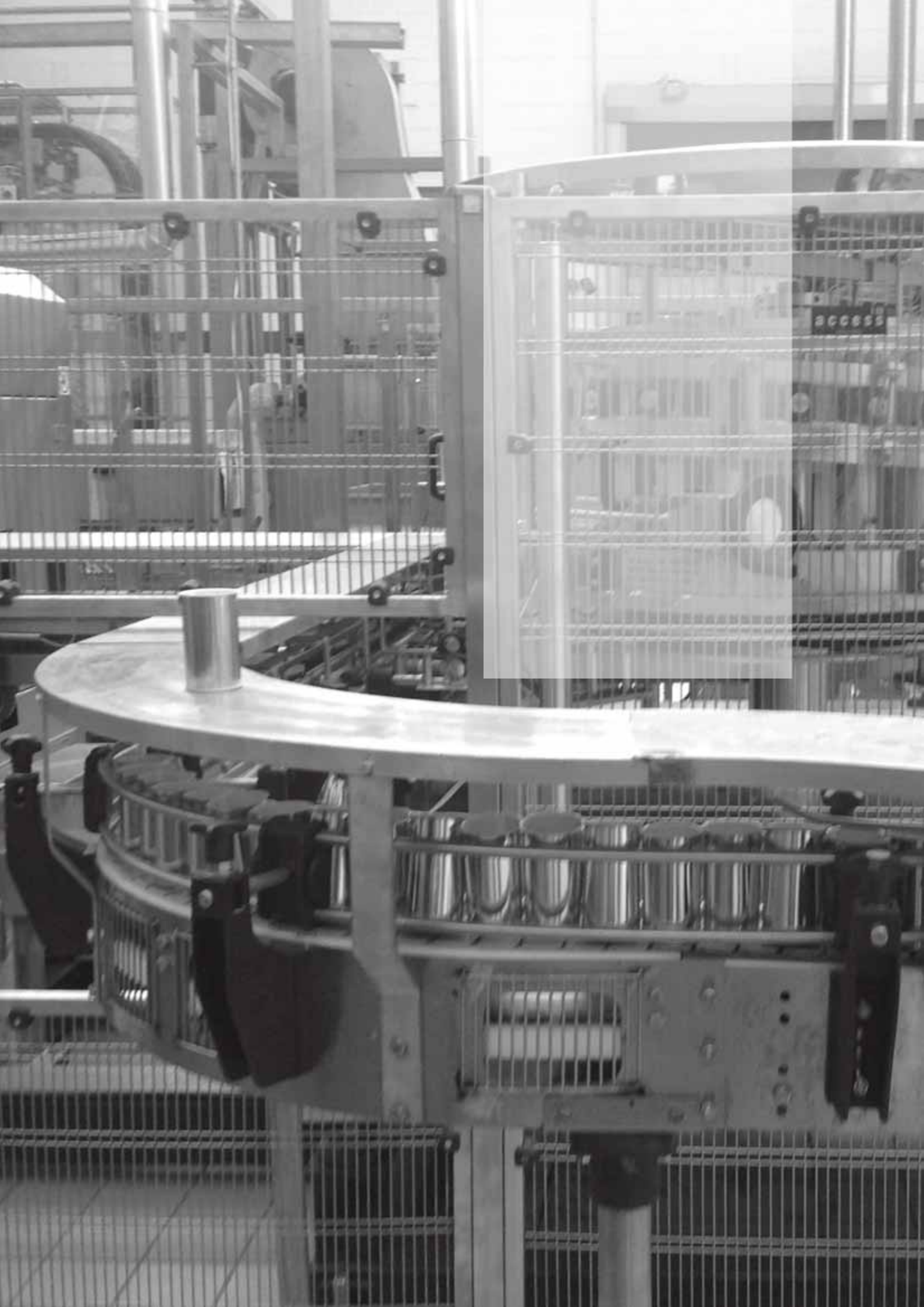

200 mm

UNI EN ISO 13857

Distance from hazard zone

UNI EN ISO 14120

Self-certification
in combination with META INOX No Food posts

UNI EN ISO 1672-2

More info on page 82

**For machinery in the
chemical and food industry
with no food contact (No
Food)**

FIELD OF APPLICATION

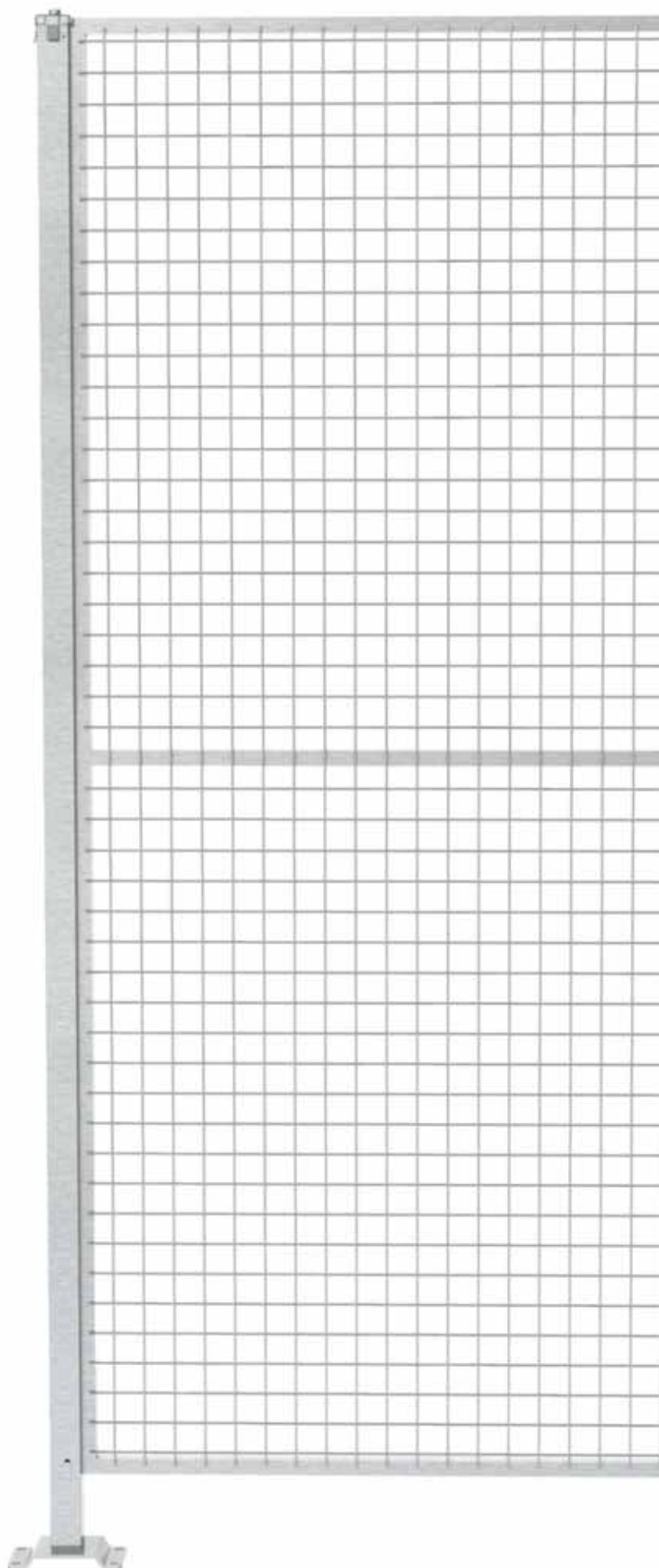

INOX NO FOOD RANGE

AISI 304 stainless steel guards for No Food machinery safety are realized with electro-welded mesh 40x40mm 3mm thread. The frame comes in the following sizes:

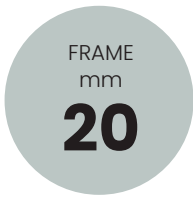

The easy to clean and sanitize panels are used to achieve machinery and plant safety when there is no chance of contact with food or other types of products manufactured.

These guards are employed to achieve safety of plants and machinery for which the distance from the hazard zone required is equal or above 200mm.

250 400 700 800 1000 1200 1500 (mm)

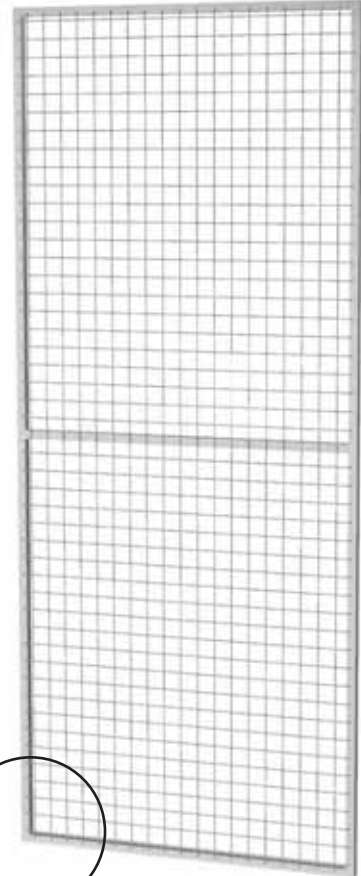

2200
1900
1500

MESH: 40x40mm thread 3mm

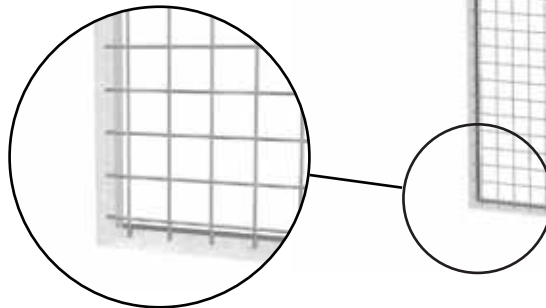

COMPATIBILITY

META INOX No Food panel to post fixing system

SURFACE TREATMENT

Polishing

20 mm

UNI EN ISO 13857

Distance from hazard zone



UNI EN ISO 14120

Self-certification
in combination with META INOX Splash posts

UNI EN ISO 1672-2

More info on page 82

For machinery in the chemical and food industry with food contact (Splash)



FIELD OF APPLICATION

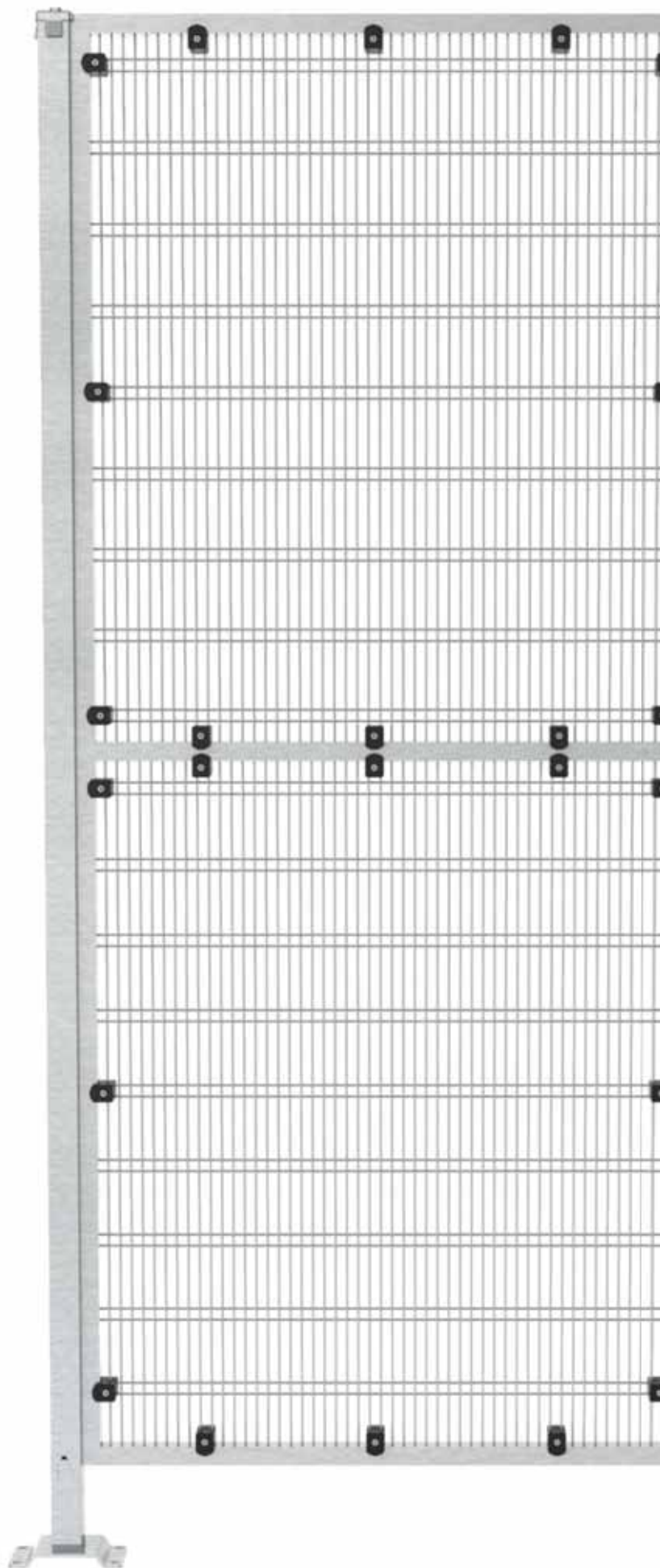

INOX SPLASH RANGE

Splash range mesh guards for machinery safety are manufactured in AISI 304 Stainless steel. They employ TEC anti finger mesh guards 15x105x15mm 3mm thread. Frame comes in the following versions:

FRAME
mm

25

The tubular has no holes and is fitted with fixing clamps made of a techno-polymer for food applications which allow easy removal of mesh for better cleaning.

Such guards are used in the food, chemical and pharmaceutical industries to implement machinery and plant safety guard systems in those work areas where contact with liquids is possible and where constant maintenance is necessary. Guards must respect a 100mm distance from the hazard zone.

MESH: 15x105x15mm thread 3mm

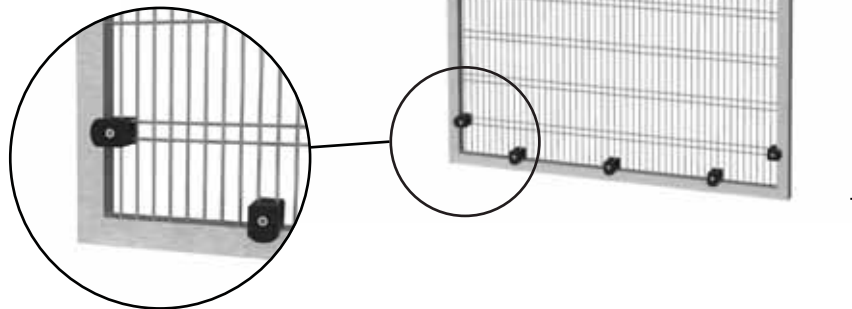

COMPATIBILITY

META INOX No Food panel to post fixing system

SURFACE TREATMENT

Polishing

META INOX NO FOOD

META posts is realised in AISI 304 stainless steel, it is easy di clean and sanitize and fits a fast retained fastening system post-to panel fixing system. Such a system meets the requirements of UNI EN ISO14120, UNI EN ISO 12100 Machinery Directive 2006/42/CE. The system comprises a Stainless Steel cap in the upper part and a laser-worked flap in the tubular post in the lower part.

META INOX NO FOOD FIXING SYSTEM EUROPEAN PATENT N° 2226451

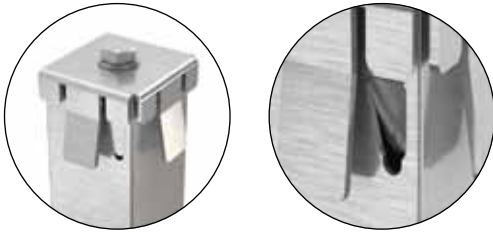

BASE, TUBULAR AND FLOOR FITTING

WELDED BASE _____



☑ **40x40** 4 M stainless steel
plugs

PLATE SIZE: 80x150mm

Raised welded base plate for liquid
outflow

COMPATIBILITY

Pannels from the INOX No Food range

SURFACE TREATMENT

Polishing

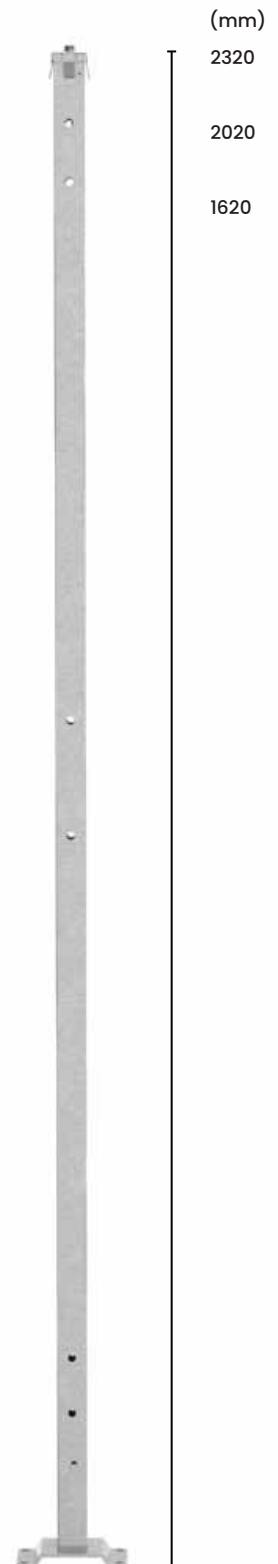

META INOX SPLASH

META post is realised in AISI 304 stainless steel, it is easy to clean and sanitize and fits a fast retained fastening system post-to-panel fixing system. Such a system meets the requirements of UNI EN ISO14120, UNI EN ISO 12100 Machinery Directive 2006/42/CE. The system comprises a Stainless Steel cap in the upper part and a laser-worked flap in the tubular post in the lower part.

META INOX SPLASH FIXING SYSTEM EUROPEAN PATENT N° 2226451



BASE, TUBULAR AND FLOOR FITTING

WELDED BASE



☑ **40x40** 4 M stainless steel
plugs

PLATE SIZE: 80x150mm

Raised welded base plate for liquid
outflow

COMPATIBILITY

Panels from the INOX Splash range

SURFACE TREATMENT

Polishing

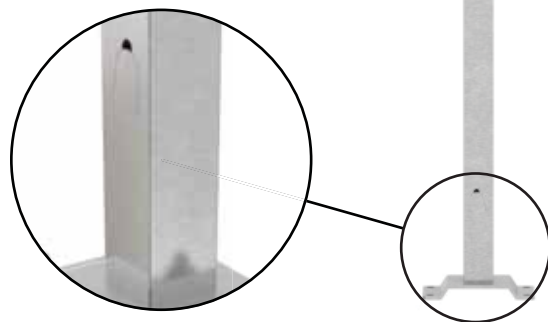

(mm)

2331

2031

1631

Over the years Accessafe has designed a range of accessories able to solve problems which may occur during assembly or to complete the fencing systems with sensors and support components.

01. PANEL CONNECTION KIT

This accessory is used to connect panels.

COMPATIBILITY

INOX No Food guard systems



02. META END INTERMEDIATE FIXING KIT

This accessory allows to fix META INOX posts and panels when height drops are present. Available as end type.

COMPATIBILITY

INOX No Food guard systems

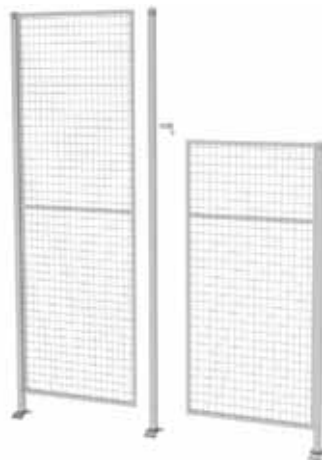

03. META LINEAR IN-LINE FIXING KIT

This accessory allows to fix META INOX posts and panels when height drops are present. Available as in-line type.

COMPATIBILITY

INOX No Food guard systems





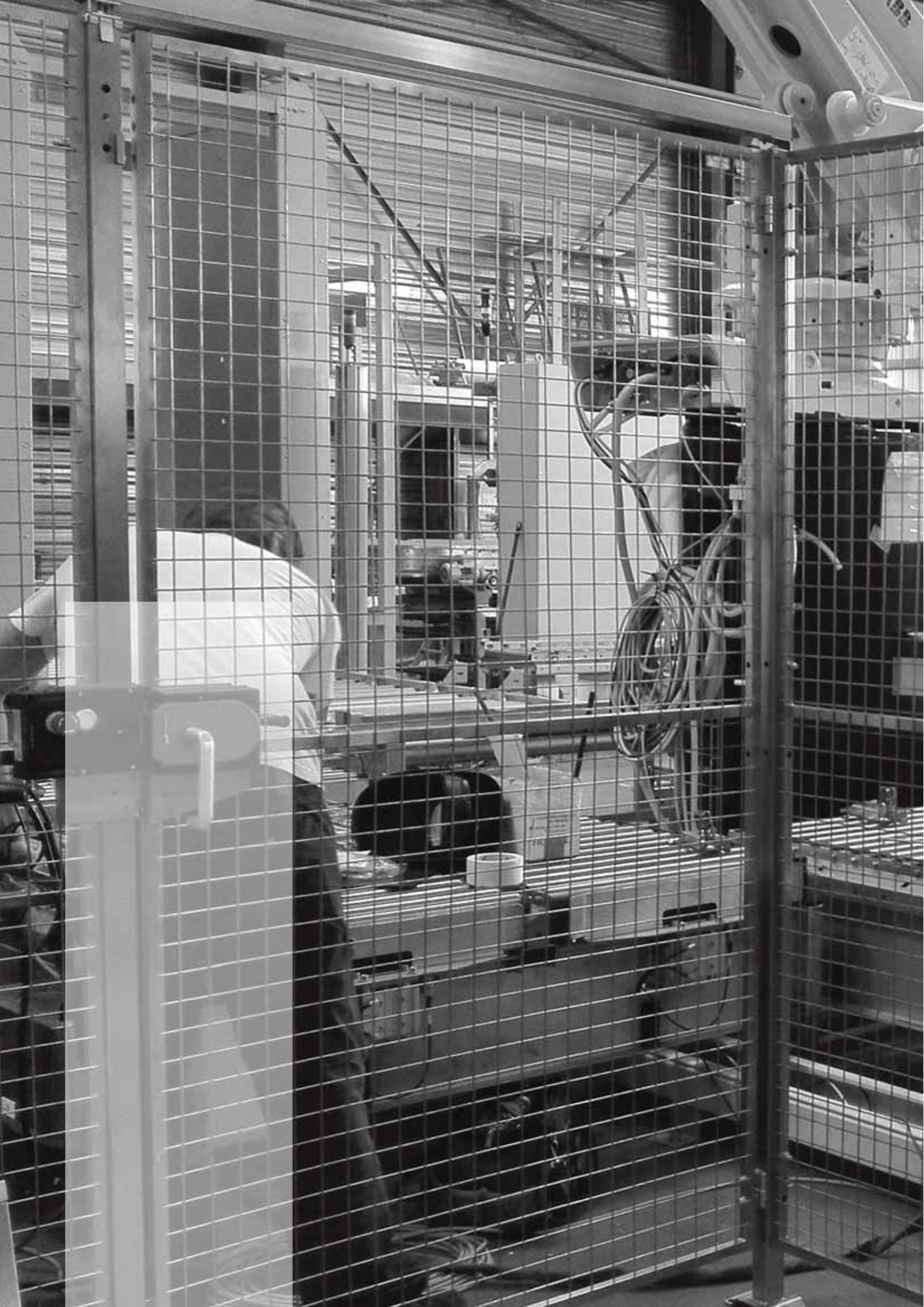



HINGED AND SLIDING DOORS



Accesssafe hinged and sliding doors follow the “door-in-a-box” concept and come with posts and accessories. Panels need to be purchased separately.

Upon request doors can be equipped with different type of lock housings in order to fit the preferred locking system. For this purpose, Accesssafe offers a wide range of dedicated or universal housings which allow to install safety switches of the main international brands.

DOOR TYPES

SINGLE LEAF HINGED DOOR

DOUBLE LEAF HINGED DOOR

UPPER BINARY SLIDING DOOR

COMPATIBILITY

All doors are compatible with guard systems realised with INOX No Food or Splash systems and their pertinent posts.

SURFACE TREATMENT

POLISHING

SINGLE LEAF HINGED DOOR INOX NO FOOD

Single leaf hinged doors are fitted with AISI304 steel hinges. For guard systems realized with META INOX No Food posts, the door can be built using panels from the same range. Doors can be ordered pre-assembled in factory or can be delivered as "Door in a box". Purchase includes posts and accessories for on-site assembly but door panels need to be purchased separately.

All doors are fitted with floor fixing plugs and provide retaining bolts as per UNI EN ISO 14120.



LOCKING SYSTEMS



LATCH

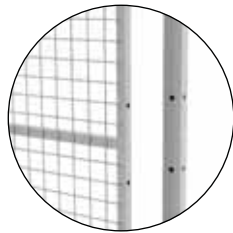

CLOSING NOT REQUIRED

BASE, TUBULAR AND FLOOR FITTING

WELDED BASE



☑ **40x40** 4 M stainless steel plugs

PLATE SIZE: 80x150mm

Raised welded base plate for liquid outflow

TRANSOM



WITH

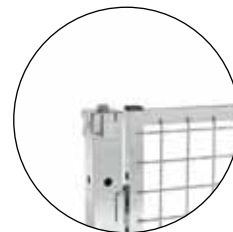

WITHOUT

DOUBLE LEAF HINGED DOOR INOX NO FOOD

Double leaf hinged doors are fitted with AISI304 steel hinges. For guard systems realized with META INOX No Food posts, the door can be built using panels from the same range. Doors can be ordered pre-assembled in factory or can be delivered as "Door in a box". Purchase includes posts and accessories for on-site assembly but door panels need to be purchased separately.

All doors are fitted with floor fixing plugs and provide retaining bolts as per UNI EN ISO 14120.



LOCKING SYSTEMS

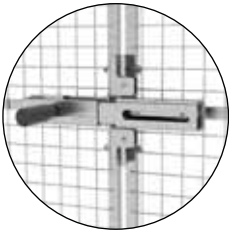

BARREL BOLT

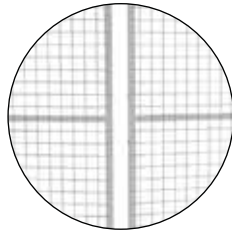

CLOSING NOT REQUIRED

BASE, TUBULAR AND FLOOR FITTING

WELDED BASE _____



☑ **40x40** 4 M stainless steel plugs

PLATE SIZE: 80x150mm

Raised welded base plate for liquid outflow

TRANSOM



WITH

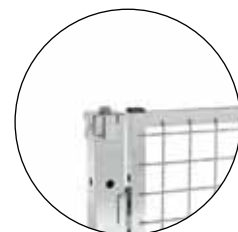

WITHOUT

SINGLE LEAF HINGED DOOR INOX SPLASH

Single leaf hinged doors are fitted with AISI304 steel hinges. For guard systems realized with META INOX SPLASH posts, the door can be built using panels from the same range. Doors can be delivered pre-assembled in factory or as "Door in a Box". All posts and accessories for assembly on site are supplied whereas door panels must be purchased separately. All doors are fitted with floor fixing plugs and come with retaining bolts as per UNI EN ISO 14120.



LOCKING SYSTEMS



LATCH

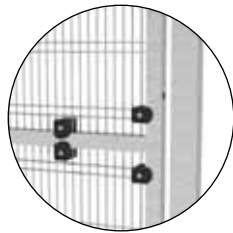

CLOSING NOT REQUIRED

BASE, TUBULAR AND FLOOR FITTING

WELDED BASE _____



☑ **40x40** 4 M stainless steel plugs

PLATE SIZE: 80x150mm

Raised welded base plate for liquid outflow

TRANSOM

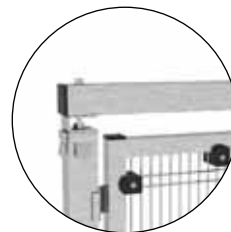

WITH

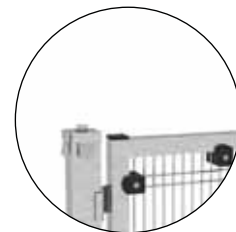

WITHOUT

DOUBLE LEAF HINGED DOOR INOX SPLASH

Double leaf hinged doors are fitted with AISI304 steel hinges. For guard systems realized with META INOX SPLASH posts, the door can be built using panels from the same range. Doors can be delivered pre-assembled in factory or as "Door in a Box". All posts and accessories for assembly on site are supplied whereas door panels must be purchased separately. All doors are fitted with floor fixing plugs and come with retaining bolts as per UNI EN ISO 14120.



LOCKING SYSTEMS

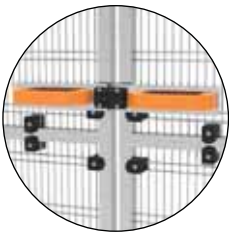

LATCH

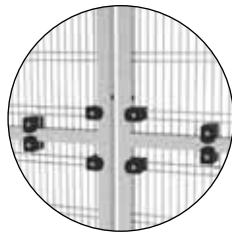

CLOSING NOT REQUIRED

BASE, TUBULAR AND FLOOR FITTING

WELDED BASE _____



☑ **40x40** 4 M stainless steel plugs

PLATE SIZE: 80x150mm

Raised welded base plate for liquid outflow

TRANSOM

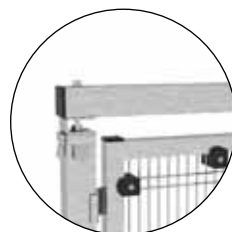

WITH

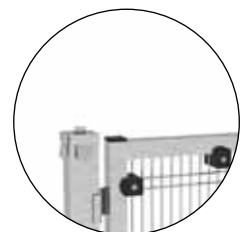

WITHOUT

UPPER BINARY

SINGLE OPENING

INOX NO FOOD

Upper binary sliding door with single opening is composed by an extra-resistant aluminium rail fixed to posts by means of suitable sleeves. Doors can be built using only panels from the INOX No Food range.

Doors can be delivered pre-assembled in factory or as "Door in a Box". All posts and accessories for assembly on site are supplied whereas door panels must be purchased separately. All doors are fitted with floor fixing plugs and come with retaining bolts as per UNI EN ISO 14120.



LOCKING SYSTEMS



LATCH

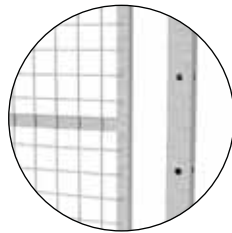

CLOSING NOT REQUIRED

BASE, TUBULAR AND FLOOR FITTING

WELDED BASE



☑ **40x40** 4 M stainless steel plugs

PLATE SIZE: 80x150mm

Raised welded base plate for liquid outflow

UPPER BINARY

SINGLE OPENING

INOX SPLASH

Upper binary sliding door with single opening is composed by an extra-resistant aluminium rail fixed to posts by means of suitable sleeves. Doors can be built using only panels from the INOX Splash range.

Doors can be delivered pre-assembled in factory or as "Door in a Box". All posts and accessories for assembly on site are supplied whereas door panels must be purchased separately. All doors are fitted with floor fixing plugs and come with retaining bolts as per UNI EN ISO 14120.



LOCKING SYSTEMS

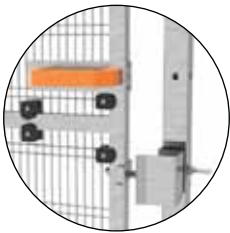

LATCH

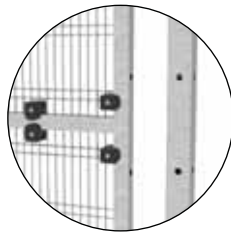

CLOSING NOT REQUIRED

BASE, TUBULAR AND FLOOR FITTING

WELDED BASE —————



☑ **40x40** 4 M stainless steel plugs

PLATE SIZE: 80x150mm

Raised welded base plate for liquid outflow

INOX RANGE LOCKING SYSTEMS

SINGLE LEAF HINGED DOOR NO FOOD

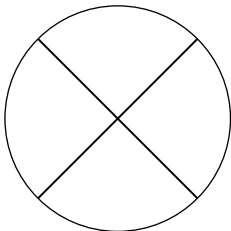
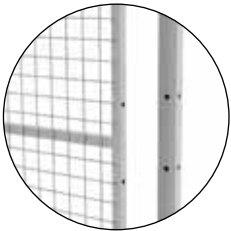

DOUBLE LEAF HINGED DOOR NO FOOD

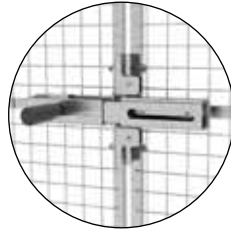
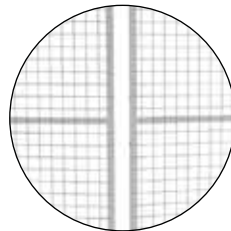
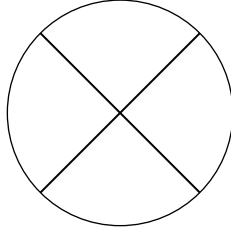

DESCRIPTION

01. LATCH

Brass mechanic groove and tongue lock.

COMPATIBILITY

All panels in the INOX No Food Range

02. CLOSING NOT REQUIRED

Lock-free system for optional fitting of accessories such as a safety push bar or safety electronic locks.

COMPATIBILITY

All panels in the INOX No Food Range

03. BARREL BOLT

Mechanic lock with horizontal sliding barrel bolt with handle included.

COMPATIBILITY

All panels in the INOX No Food Range

SINGLE LEAF HINGED DOOR SPLASH

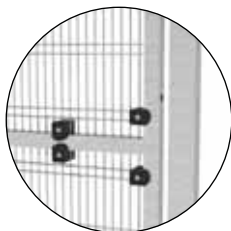
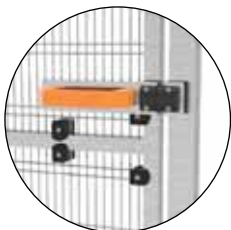

DOUBLE LEAF HINGED DOOR SPLASH

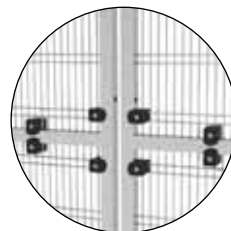
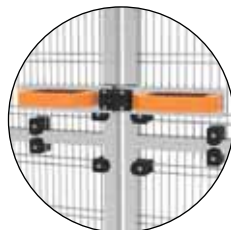

DESCRIPTION

01. LATCH

Brass mechanic groove and tongue lock.

COMPATIBILITY

All panels in the INOX Splash Range

02. CLOSING NOT REQUIRED

Lock-free system for optional fitting of accessories such as a safety push bar or safety electronic locks.

COMPATIBILITY

All panels in the INOX Splash Range

**SINGLE OPENING
SLIDING DOOR
NO FOOD**

**SINGLE OPENING
SLIDING DOOR
SPLASH**

DESCRIPTION

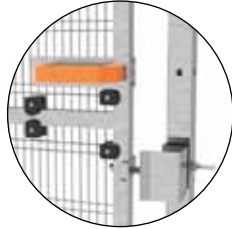

01. LATCH

Brass mechanic groove and tongue lock.

COMPATIBILITY

All panels in the INOX Range

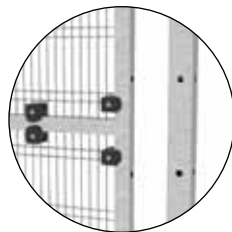
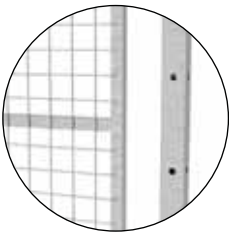

02. CLOSING NOT REQUIRED

Lock-free system for optional fitting of accessories such as a safety push bar or safety electronic locks.

COMPATIBILITY

All panels in the INOX Range





FIELD OF APPLICATION

MATERIAL HANDLING AND LOGISTICS



Accessafe Material handling and logistics range includes SI.SMA panels to prevent accidental falling of material from racks, mesh shelves, pressed gratings shelves which stock materials such as: pallets, boxes, single items.

ANTI-COLLAPSE PANELS COLOURS (RAL)

Panels undergo epoxy coating

● 9005

● 1018

● 7035

Other colours available upon request

MESH RACK SURFACE TREATMENT

GALVANIZATION

UNI EN ISO 3834-3

Welding 3834-3 ICIM : 3834-100009-00

**For all types of segregation
connected to material
handling and logistics**

FIELD OF APPLICATION

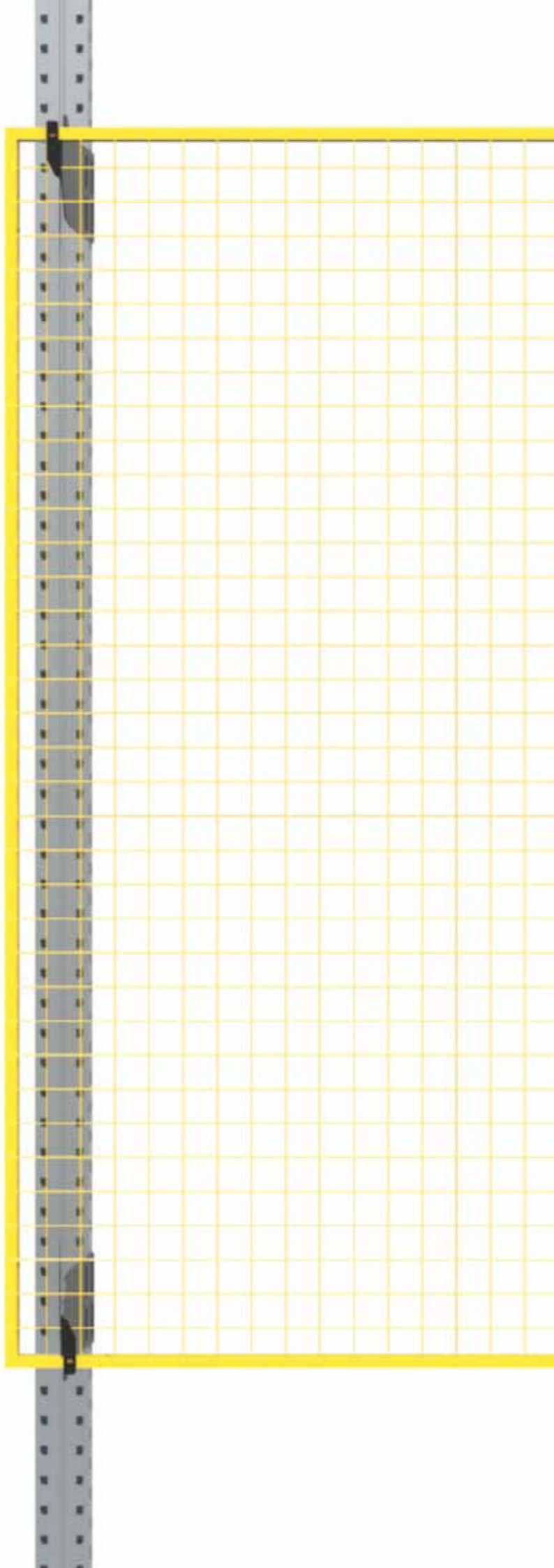

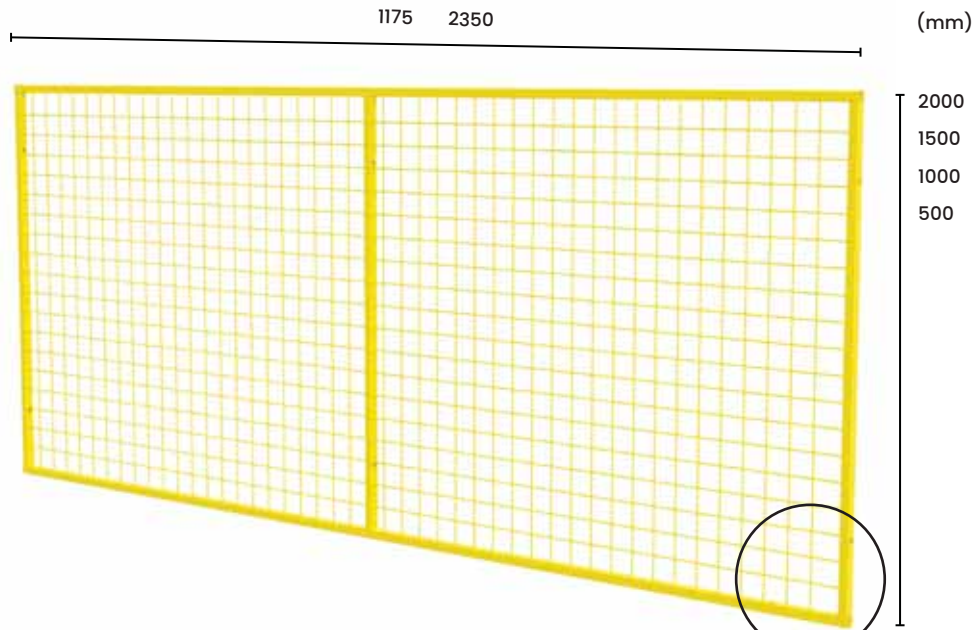

SI.S.MA ANTI COLLAPSE PANELS

SI.S.MA anti-collapse guards are realized in electro-welded mesh, 50x50mm mesh, 3 mm thread. They are designed to prevent accidental falling of material stocked on shelves. The frame comes in the following versions:

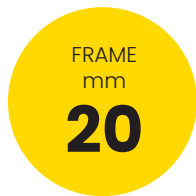

MESH: 50x50mm thread 3mm

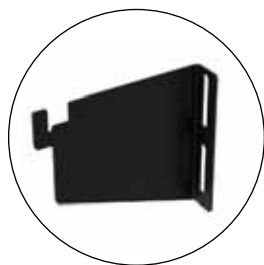

PANEL SIZE

Base (mm): 1175, 2350
Height (mm): 500, 1000, 1500, 2000

DISTANCE ANTI COLLAPSE PANEL - RACK (mm)

50, 100, 150, 200, 250, 300, 350, 400

COLOURS (RAL)

Panels undergo epoxy coating

- 9005
- 1018
- 7035

Other colours available upon request

Special connectors to fix SI.S.MA panel to the shelf have been designed to allow choice of distance between mesh and shelf.

The exclusive design of the connection systems allow to join any shelf or profile, without any limitation of size, height and width.



ACCESSORIES FOR MATERIAL HANDLING AND LOGISTICS

Over the years Accessafe has designed a range of accessories able to solve problems which may occur during assembly or to complete the fencing systems with sensors and support components

01. SI.S.MA CONNECTOR KIT

This accessory is employed to fix the anti-collapse panels to the shelves.

Depth (mm): 50, 100, 150, 200, 250, 300, 350, 400

COMPATIBILITY

SI.S.MA range

02. SI.S.MA EXTENSION KIT

This accessory is employed to fix the anti-collapse panels to the shelves in case of height protrusions (depth 150mm) for the HI000 panel.

<i>h/p (mm)</i>	50	100	150
1000			•
1500	•	•	•

COMPATIBILITY

SI.S.MA range

03. CUTTING KIT

This accessory is employed to resize SI.S.MA panels in height and width.

COMPATIBILITY

SI.S.MA range

01 SI.S.MA CONNECTOR
KIT



02 SI.S.MA EXTENSION
KIT



03 CUTTING
KIT

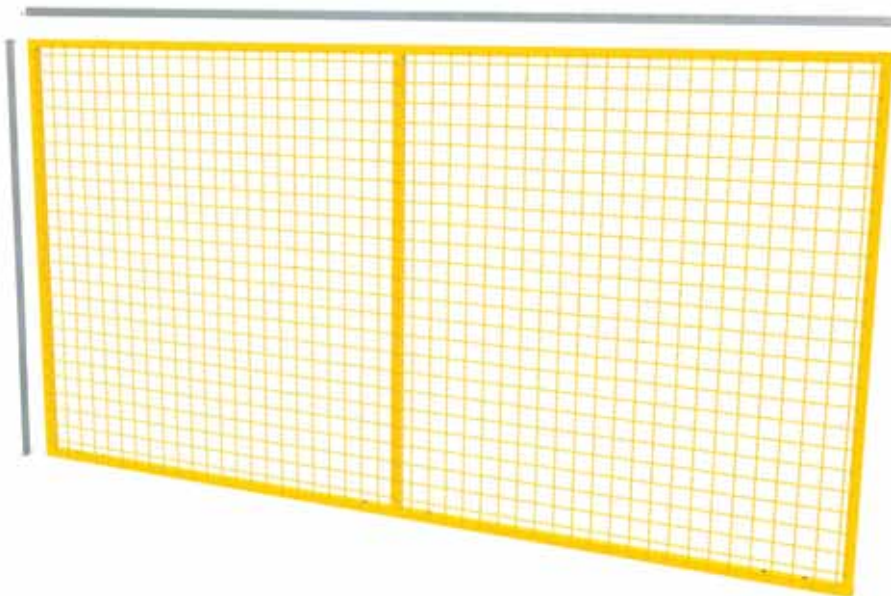

SHELF MESH RACKS

Accessafe SHELF mesh racks have been designed to guarantee support to pallets stocked upon pallet racks. The main function of this product is to prevent accidental falling of the pallets or of other stocked packaging. Accessafe SHELF mesh racks are able to guarantee an appropriate support thanks to their structure made of section breakers welded directly to the mesh.

The shelves are composed by a 50x100mm mesh and guarantees a free opening of over 70% making the product suitable for installation in areas with sprinkler fire extinguisher systems.

Shelf mesh racks can be manufactured in different sizes and workloads according to customer requirements and do not need fixing accessories making installation simple and quick.



TECHNICAL FEATURES

- Thread (mm): 3,8 + 4,3
- Mesh (mm): 50x100
- Reinforcement frames: 3, 4, 5 according to workloads
- Workloads (kg): 800, 1000, 1500
- Load print: uniformly distributed
- Finishing: pre-galvanized
- Standard flow (mm): 50

NORMS

- EN 15512/2020

Table of mesh decks

Workload (kg)	Width (mm)	Length (mm)	Mesh (mm)	Frames
1500	1100	1340	50*100	5
1000	800	1340	50*100	4
1000	1000	880	50*100	4
1000	1000	1340	50*100	4
1000	1100	1340	50*100	4
1000	1200	1340	50*100	4
800	800	880	50*100	3
800	1000	880	50*100	3
800	1000	1090	50*100	3
800	1050	880	50*100	3
800	1070	880	50*100	3
800	1100	880	50*100	3
800	1200	880	50*100	3

PRESSED GRATINGS RACKS

Accessafe pressed gratings racks have been designed to guarantee support to pallets stocked on pallet holders.

The main function is to prevent accidental falling of the pallets or the packaging stocked there. Thanks to their versatility, Accessafe pressed gratings racks are employed in warehouses in which stocked products have different load prints and shapes because these racks are able to consistently guarantee workload.

The racks lay on the frames and thanks to their special conformation they do need fixing systems.

The main feature of this product is the hot-galvanization finishing which guarantees resistance in time even should corrosive substances be employed or should they be employed outdoors. Pressed gratings racks can be manufactured in different sizes and workloads according to rack requirements.

TECHNICAL FEATURES

- Mesh (mm): 33/66, 44/9, 66/99, 99/66
- Reinforcement frames: 2*80, 2*68
- Workload (kg): 350, 500, 800, 1000
- Plate: 20/2
- Finishing: pre-galvanized

NORMS

- EN 15512/2020

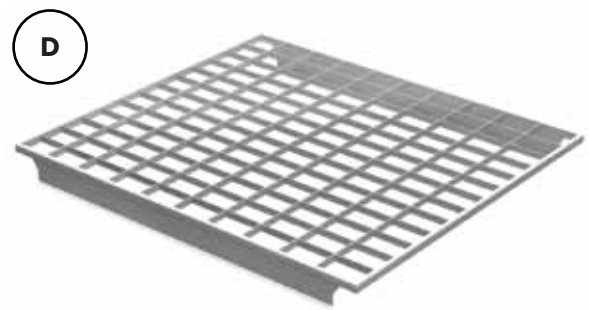
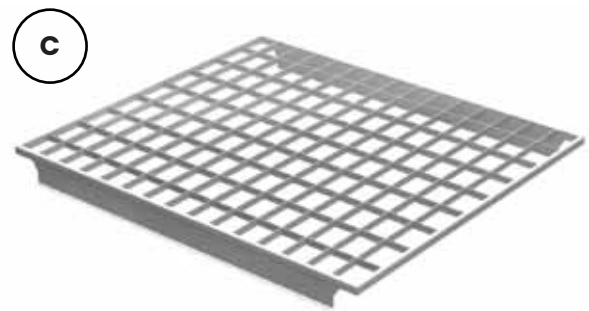
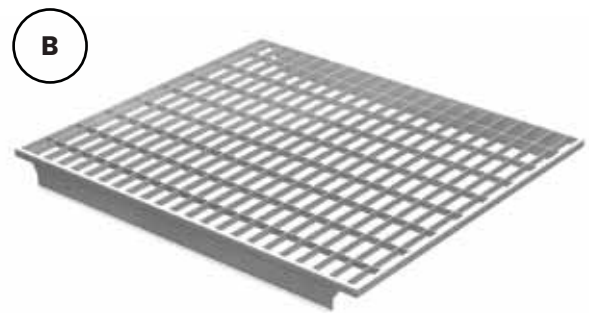

Table of gratings racks 880x1100mm

Type	Workload (kg)	Width (mm)	Length (mm)	Mesh (mm)	Plate (mm)	Frame
A	1000	800	1100	33/66	20/2	2x80
B	800	800	1100	44/99	20/2	2x80
C	500	800	1100	66/99	20/2	2x68
D	350	800	1100	99/66	20/2	2x68

Table of gratings racks 880x1050mm

Type	Workload (kg)	Width (mm)	Length (mm)	Mesh (mm)	Plate (mm)	Frame
A	1000	800	1050	33/66	20/2	2x80
B	800	800	1050	44/99	20/2	2x80
C	500	800	1050	66/99	20/2	2x68
D	350	800	1050	99/66	20/2	2x68

Table of gratings racks 880x1000mm

Type	Workload (kg)	Width (mm)	Length (mm)	Mesh (mm)	Plate (mm)	Frame
A	1000	800	1000	33/66	20/2	2x80
B	800	800	1000	44/99	20/2	2x80
C	500	800	1000	66/99	20/2	2x68
D	350	800	1000	99/66	20/2	2x68



QUALITY

For Accessafe Quality is not only process certification. In fact, quality is understood as designing and engineering systems which are compatible with the tear and wear of daily use and long lasting. Every detail, be it mechanical or metal working, is designed to integrate a number of factors such as effective safety, current regulations, weight, visibility, easy assembly and endurance in extensive daily use. Accessafe carries out sample pressure tests on standard components, pre-assembly of mechanic details and functionality tests on automated movable guards. Finally, Accessafe checks that every single packaging contains machine layout, that assembly kits are packed in separate boxes with assembly instructions.



Accessafe makes its 3D library available to customers through its site [traceparts.com](https://www.traceparts.com). Customers can have access to all Accessafe products: panels, posts and accessories and they can download the 3D files in their preferred designing format (compatible formats: Autodesk, Solidworks, Catia etc.). For more complex assemblies such as doors, Accessafe has studied and developed a graphic configurator which will guide customers in the choice of the required model, generation of the 3D file and the commercial code needed for product design and purchase.

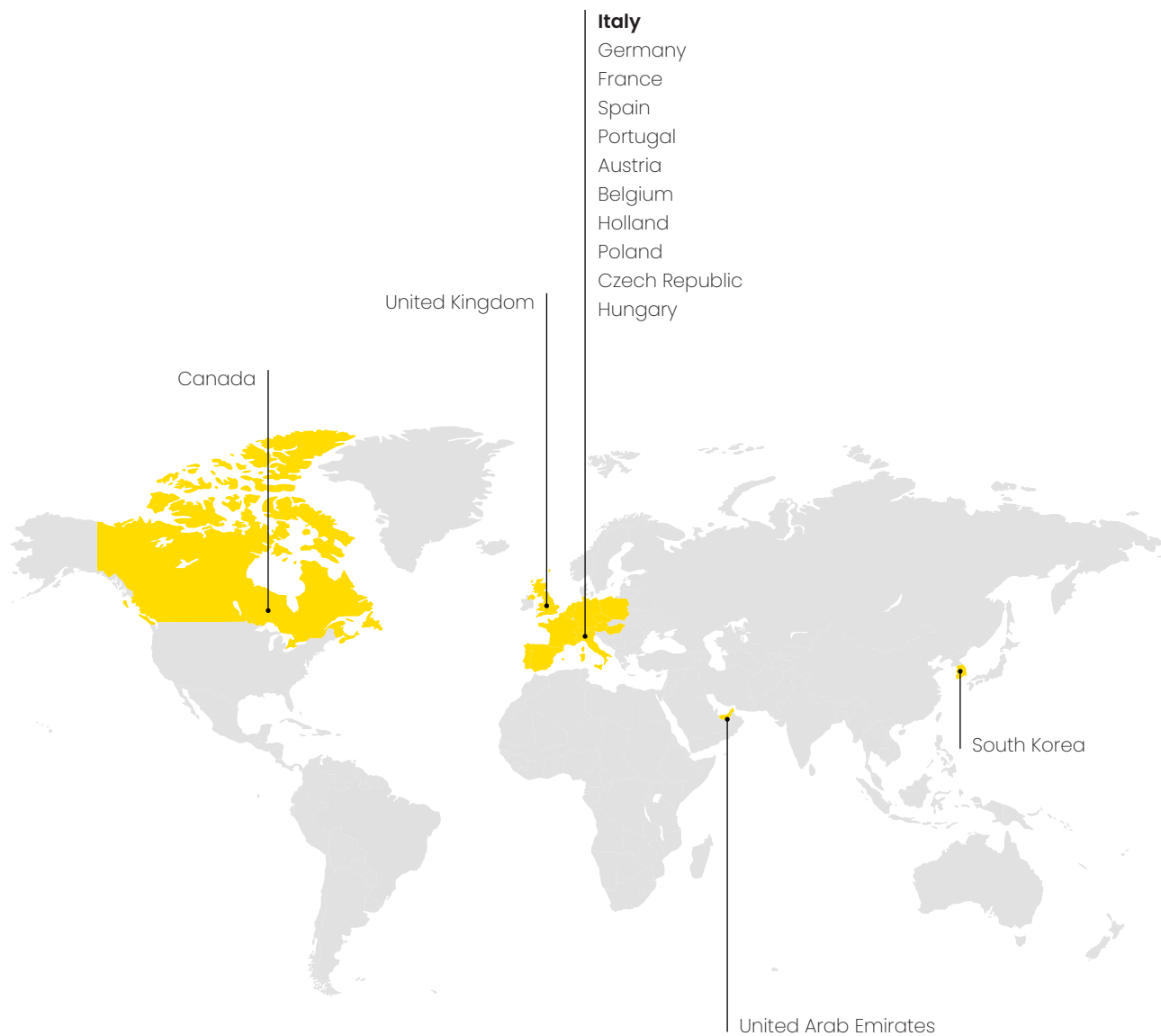

CONTACTS

Access S.r.l.

FACTORY ADDRESS

Via delle Industrie, N° 11 - 20883 Mezzago (MB) - Italy

HEADQUARTERS

Via Provinciale 56, N° 56 - 23879 Verderio (LC) - Italy

+39 039.9515951
fast@accessafe.eu

accessafe.eu



